

# 2U3-BAY EDGE COMPUTING

# SERVER CHASSIS Product Manual V1.0

# CONTENTS

Chapter 1: Product Introduction.....	02
1.1 Product features.....	02
1.2 Chassis Structure.....	03
1.2.1 Chassis Diagram.....	03
1.2.2 Hard Drive Installation and Hard Drive Tray Indicator Light Instructions	05
Chapter 2: Product Appearance.....	06
2.1 Chassis Structure.....	06
2.1.1 Server Chassis Images.....	06
2.1.2 Server Dimensions.....	07
Chapter 3: Product Loading.....	08
3.1 Product Packaging.....	08
Chapter 4: Accessory Name and Part Number .....	09
4.1 Accessories and Material Numbers.....	09
4.2 Optional Accessories List.....	10

# Chapter 1: Product Introduction

## 1.1 Product Features

Product Code	K22031	K22032
Chassis category	2U Rack mount	
Material	SGCC1.2mm(Taiwan)	
MB Form Factor	Extended ATX (12"x 13")	
Dimensions (D*W*H)	480 * 435 * 88.1(mm) 18.9"x 17.12"x 3.47 "	
Drive Bays	3.5"Hot-swap: 3 , Internal 2.5": 2, 2.5"Hot-swap (Option): 2	
PSU Form Factor	2U Single or 1+1 Redundant	
Indicators	1 x Power Status, 1 x HDD Activity , 2 x LAN Activity	
Front Control	1 * Power On/Off , 1 * System Reset, 1 * UID 2 * USB 2.0 , USB3.0 + VGA(Optional)	
Safety Device	Intrusion Switch (Option)	
Cooling Fans	Middle: 3 x 80mm (T=38mm), PWM, 7500RPM	Middle: 2 x 80mm (T=38mm), PWM, 15000RPM Middle : 1 x 80mm (T=38mm) , PWM, 7500RPM
Expansion Slots	Length or; 7 x Low Profile	Supports 2nd; PCIe, 3X Full Heigh
Riser card module	No	PCIe16x 3.0, PCIe16x 4.0(Optional)
HDD Backplane	3-port 12Gb/s - SAS	
Rack rails	P/N:0304100006(Optional)	
Net Weight	??kg	
Gross Weight	??kg	
Package Size(D*W*H)	??x??x??mm	

## 1.2 Chassis Structure

### 1.2.1 Chassis Diagram:

K22031:

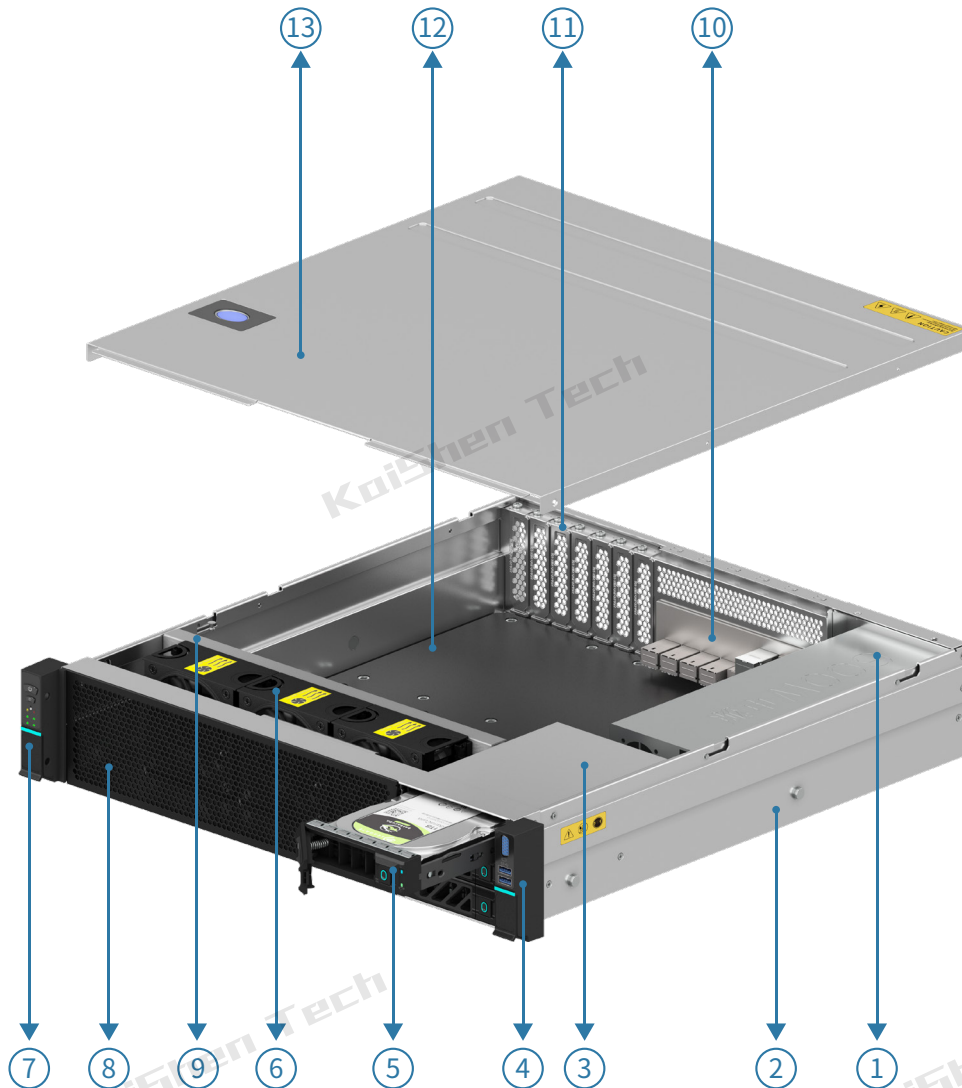

- |  |                                     |
|--|-------------------------------------|
| 1. Power Supply  | 8. Front Panel                      |
| 2. Chassis Base  | 9. Fans wall                        |
| 3. Hard disk rack  | 10. I/O shield                      |
| 4. Right Bracket Assembly(M:Aluminum Alloy)                    | 11. Standard 7 PCIe Expansion Slots |
| 5. 3.5-inch Hard Drive Tray<br>(Supports 2.5-inch Hard Drives) | 12. Gasket                          |
| 6. Cooling fans  | 13. Cover                           |
| 7. Left Bracket Assembly(M:Aluminum Alloy)                     |                                     |

K22032:

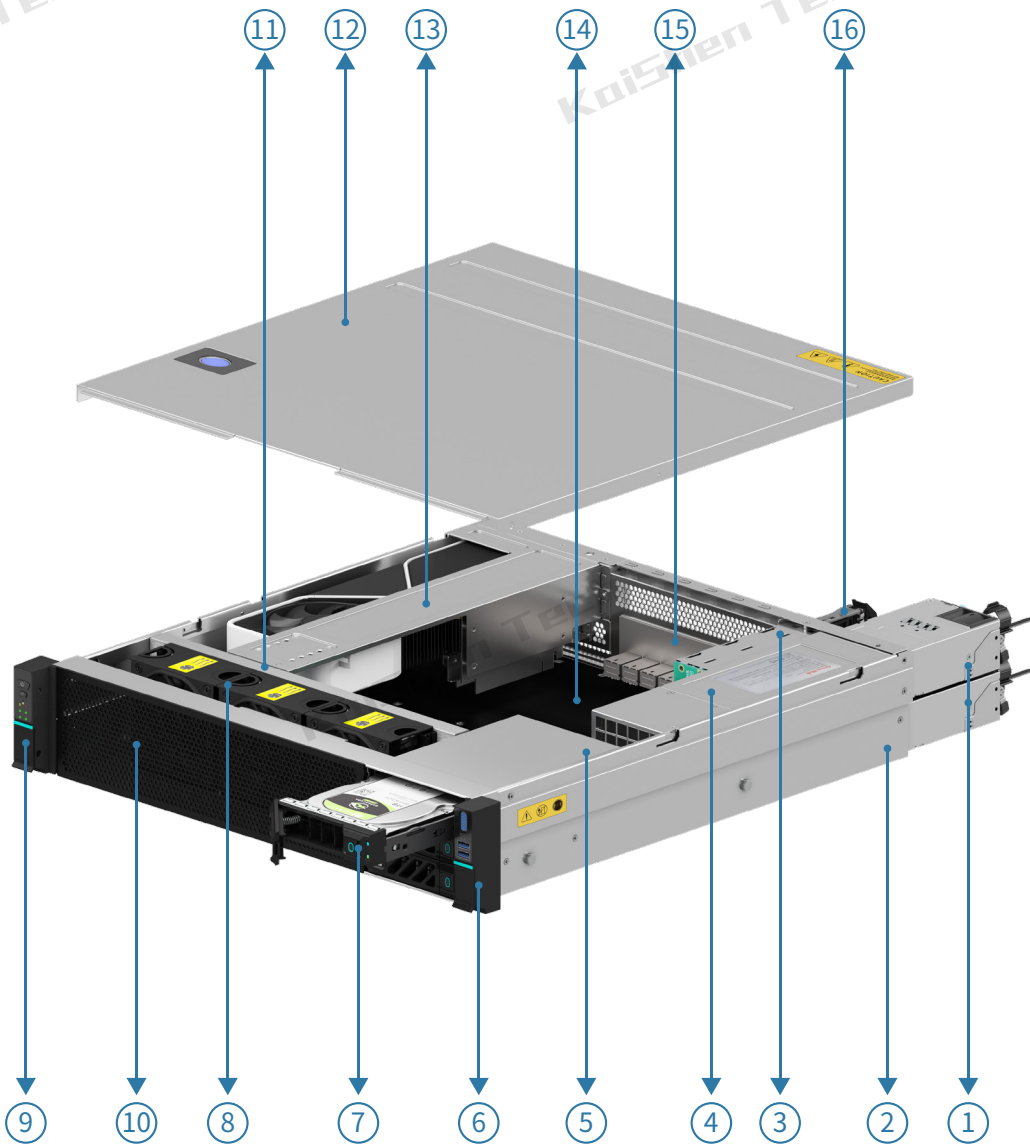

- |  |  |
|--|--|
| 1. Power Supply  | 10. Front Panel                                      |
| 2. Chassis Base  | 11. Fans wall  |
| 3. 2.5 module  | 12. Cover  |
| 4. Power Box   | 13. GPU bracket                                      |
| 5. Hard disk rack  | 14. Gasket   |
| 6. Right Bracket Assembly(M:Aluminum Alloy)                    | 15. I/O shield                                       |
| 7. 3.5-inch Hard Drive Tray<br>(Supports 2.5-inch Hard Drives) | 16. Internal 2.5-inch Hard Drive<br>Mounting Bracket |
| 8. Cooling fans  |  |
| 9. Left Bracket Assembly(M:Aluminum Alloy)                     |  |

### 1.3.2 Hard Drive Installation and Hard Drive Tray Indicator Light Instructions:

#### 3.5-inch Hard Drive Installation Guide:

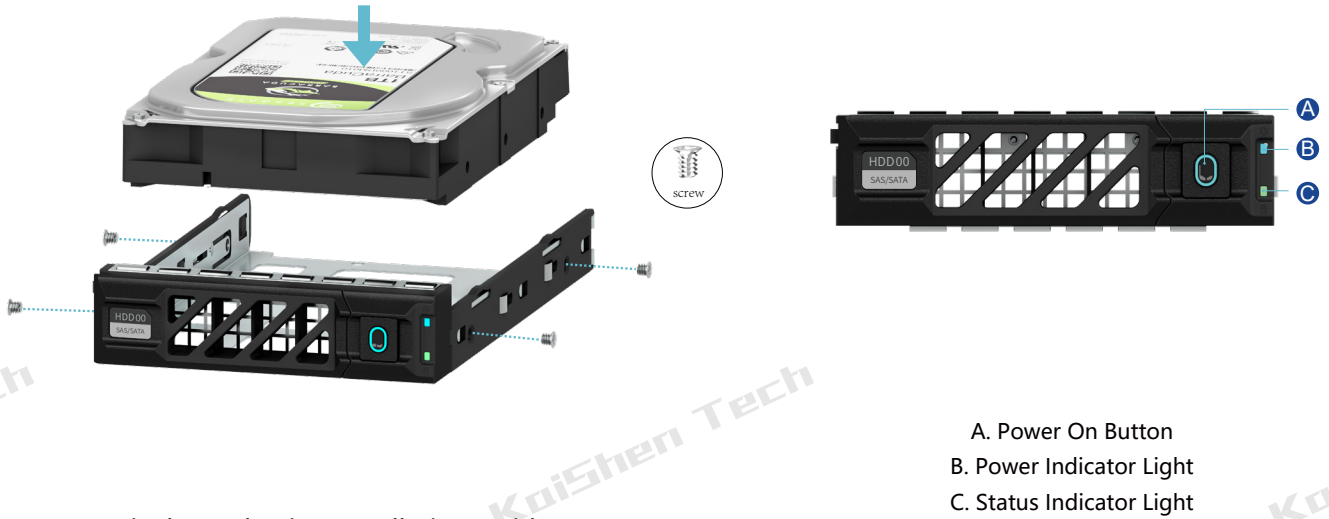

#### 2.5-inch Hard Drive Installation Guide:

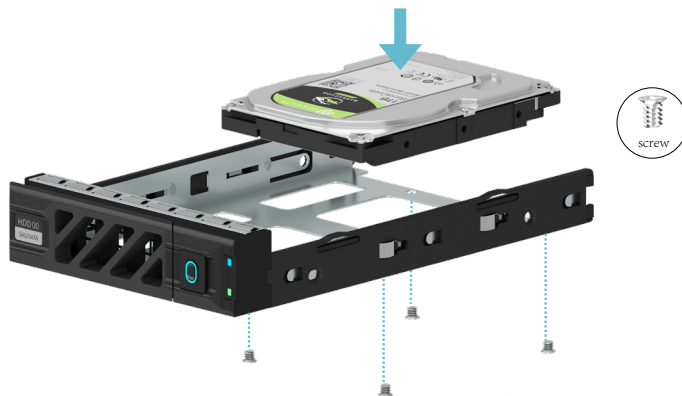

Hard Drive Tray Indicator Light Instructions	
B	Blue: Hard Drive Powered On Solid Green: Hard Drive in Position
C	Flashing Green: Hard Drive Activity Solid/Flashing Red: Hard Drive Failure

#### 2.5-inch Hard Drive Installation Guide:

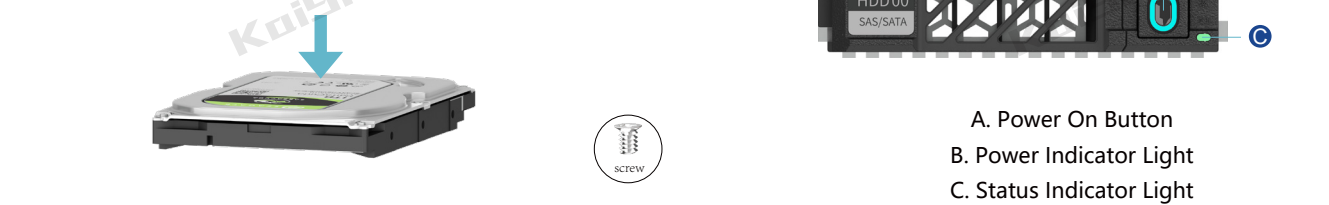

Hard Drive Tray Indicator Light Instructions	
B	Blue: Hard Drive Powered On Solid Green: Hard Drive in Position
C	Flashing Green: Hard Drive Activity Solid/Flashing Red: Hard Drive Failure

## Chapter 2: Product Appearance

### 2.1 Chassis Structure

#### 2.1.1 Server Chassis Images



Front View



45° Side View



45° Rear View(2u single)



45° Rear View(1+1 redundant)

### 2.1.2 Server Dimensions

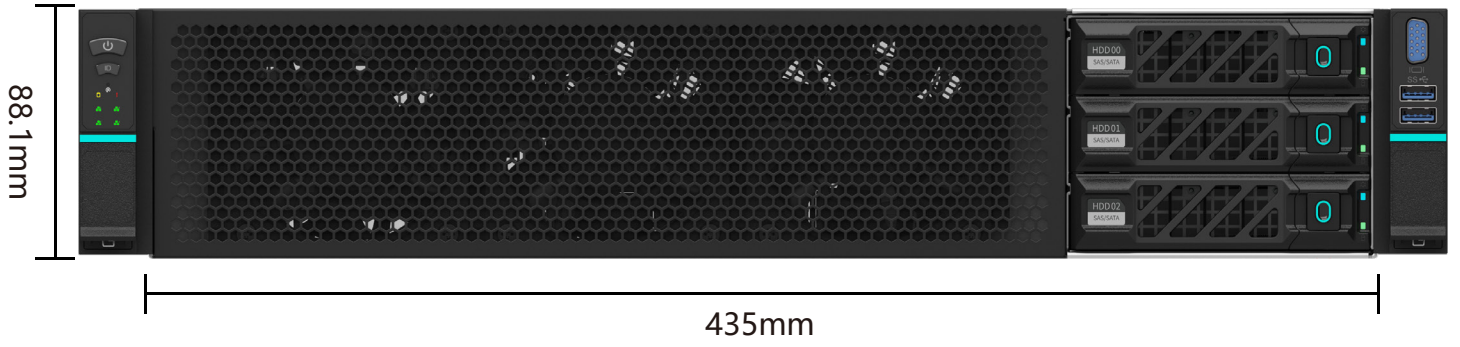

Front View (Dimensions)

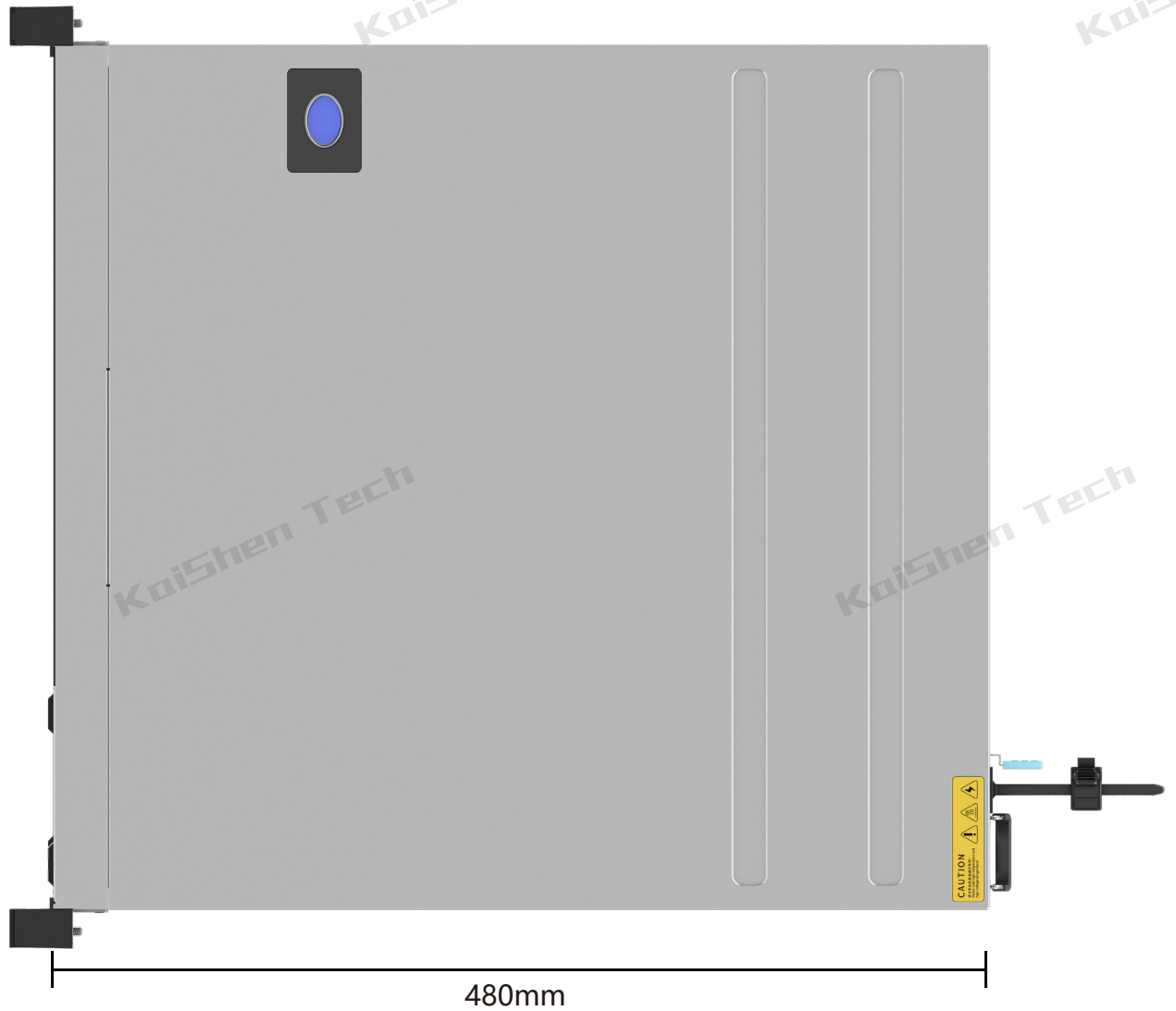

Top View (Dimensions)



## Chapter 3: Product Loading

### 3.1 Product Packaging

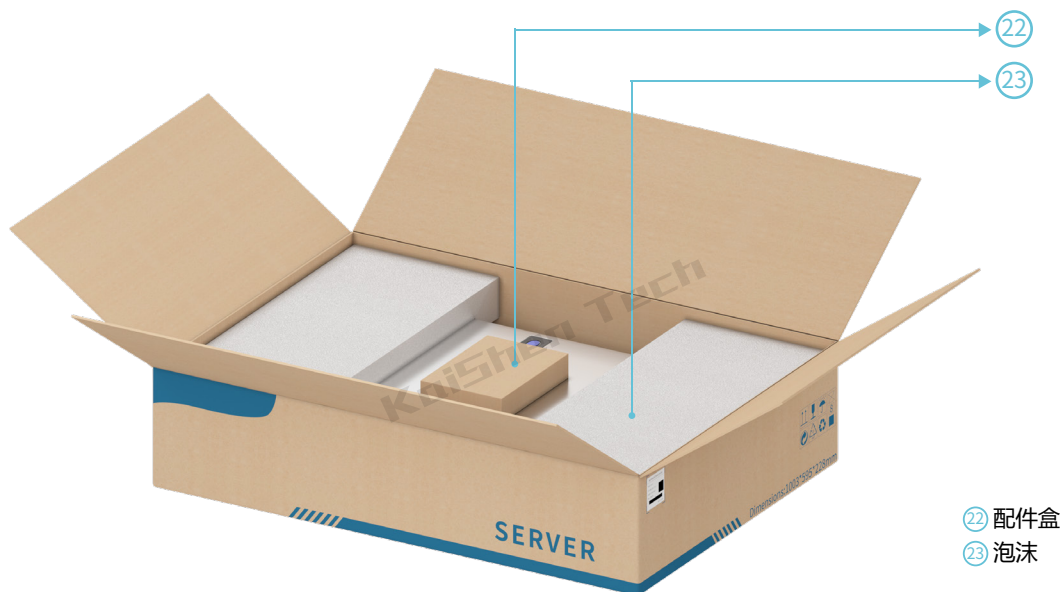

装入牛皮箱中

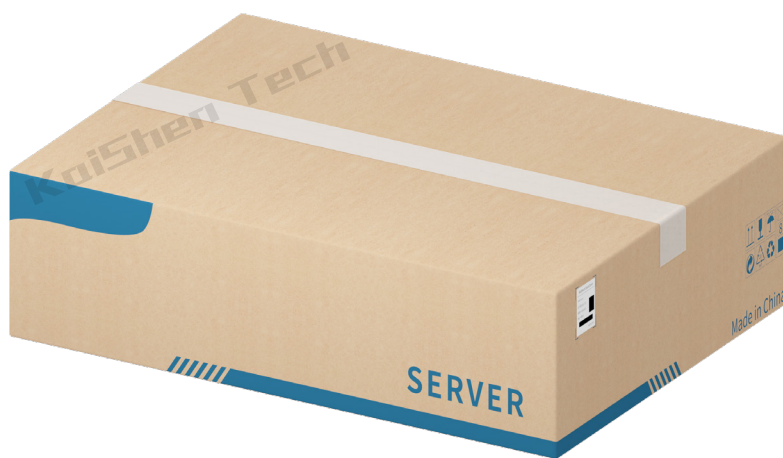

牛皮箱封箱







## Chapter 4: Accessory Name and Part Number

### 4.1 Accessories and Material Numbers(Parts Box P/N:0201070009)

No.	Part No.	Name	Photograph	Quantity
01	P/N: 0305010001	2.5-inch hard drive screws (Compatible with 3.5-inch hard drive bay)		56
02	P/N:0305010031	3.5inch hard drive screws		48
03	P/N:0305010124	2.5-inch Hard drive retaining screws		4
04	P/N:0305070003	Motherboard heightening column (Motherboard thickness1.6mm)		12
05	P/N:0305010203	Motherboard screws		12
06	P/N:0202110015	2.5Hard drive holder (2U8)		2
07	P/N:0305010125	Fixed single power/ATX		4
08	P/N:0305010025	Fixed redundancy		8
09	P/N:04.02.0009	hard drive sticker (00-11)		1

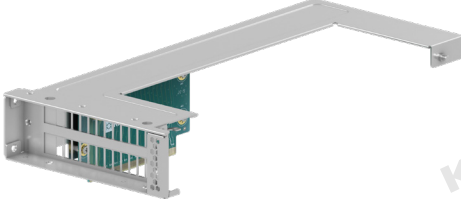
## 4.2 Optional Accessories List

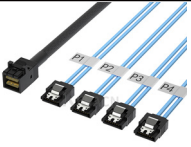
(visit the website for the detail parameter: <https://kiwaworld.com/product/10.html>)

No.	Part Number	Name	Image
01	P/N:0304100006	Slide Rail	
02	P/N:0201030001	Bracket Assembly	
03	P/N:0201090001	riser moudle	
04	P/N:0304090001	SAS (8643) cable	
05	P/N:0304090012	SAS (8643) cable	
06	P/N:0304090026	NVME cable (8654 4i to 8i)	
07	P/N:0201120006	2.5 moudle	
08	P/N:0304010016	1+1redundant power (550w)	