

4U24/4U36L Series Server Chassis

Product Manual V1.0

CONTENTS

Chapter 1: Product Introduction	02
1.1 Product features	02
1.2 Chassis Structure	03
1.3 Description of Front Panel and Hard Drive Bay	05
1.3.1 Front Panel and Indicator Lights	05
1.3.2 Hard Drive Installation and Hard Drive Tray Indicator Light Instructions	06
1.4 Hard Drive Backplane	07
1.4.1 24-Disk Backplane: 12GB/SAS*8 + Nvme*4	07
1.4.2 12-Disk Backplane: 12GB/SAS*8 + Nvme*4	08
1.5 Motherboard size	09
Chapter 2: Product Appearance	10
2.1 Chassis Structure	10
2.1.1 Chassis Diagram	10
2.1.2 Server Chassis Images	12
2.1.3 Server Dimensions	14
Chapter 3: Product Loading and Unloading	15
3.1 Removal of the Rear Top Cover	15
3.1.1 Disassembly Steps	15
3.1.2 Installation Steps	15
Chapter 4: Product Loading	16
4.1 Product Packaging	16
Chapter 5: Product and Rail Installation	17
5.1 Install inner rails on both sides of the chassis	17
5.2 The chassis is mounted into the rack	17
Chapter 6: Accessory Name and Part Number	18
6.1 Chassis Accessories List	18
6.2 Optional Accessories List	19

Chapter 1: Product Introduction

1.1 Product Features

Product Code	K34032	K34017
Chassis Category	4U Rack mount	
Material	SGCC1.2mm(Taiwan)	
MB Form Factor	L6 (448 * 424 mm)	
Dimensions (D*W*H)	780x435x177 (mm) 30.71" x 17.13" x 6.97"	
Drive Bays	3.5"Hot-swap: 24 , Internal 2.5": 2 , 2.5"Hot-swap (Option): 2	3.5"Hot-swap: 24, 3.5"Hot-swap:12, Internal 2.5": 2 , 2.5"Hot-swap (Option): 2
PSU Form Factor	1+1 Redundant	
Indicators	1 * Power Status , 2 * LAN Activity, 1 * UID Status , 1 * HDD Status, 1 Warning Status	
Front Control	Power On/Off, System Reset, 2 x USB 3.0	
Cooling Fans	Middle: 4 x 80 mm (T=38 mm) 15000 PWM, Middle: 4 x 80 mm (T=56 mm) 15000 PWM, (Option)	
Expansion Slots	24pcie TO 16pcie and 8pice(Option) , 24pcieTO 3*8x((Option) , 8654 TO 8x((Option)	
HDD Backplane	24-port12Gb/s-SAS,-Expander (Option), 2-port NVME(Option) 2-port 12GB(Option)	24 port 12Gb/s SAS, Expander 12- Port 12Gb/s SAS Expander 2-port NVME (Option), 2-port 12GB (Option) 8-port three models(Option), 8-port 12gb (Option), 4-port three models(Option), 4-port 12gb(Option),
Rack rails	P/N:0304100006(Option)	
Net Weight	27kg	27kg
Gross Weight	30.2kg	32.3kg
Package size(D*W*H)	830x600x280mm	830x600x350mm

1.2 Chassis Structure

4U24L Model Structural Diagram:

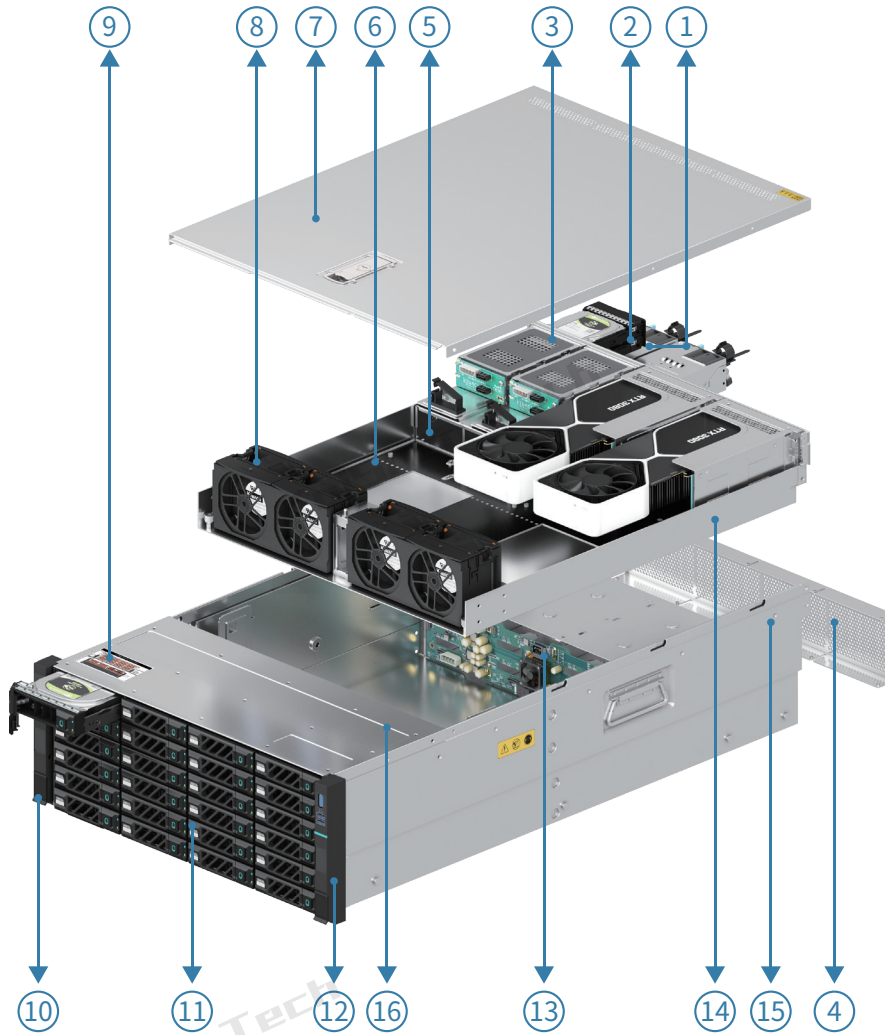

- | | |
|---|---|
| 1. Power Supply | 10. Left Bracket Assembly |
| 2. 2.5-inch Hard Drive Enclosure Module | 11. 3.5-inch Hard Drive Bracket
(Supports 2.5-inch Hard Drive) |
| 3. 2.5 Module | 12. Right Bracket Assembly |
| 4. Rear Panel | 13. Hard Drive Backplane |
| 5. Power Supply Frame | 14. Motherboard Tray |
| 6. Gasket | 15. Chassis Base |
| 7. Rear Cover | 16. Front Cover |
| 8. Fan Module | |
| 9. Chassis Layout Diagram Sticker | |

4U36L Model Structural Diagram:

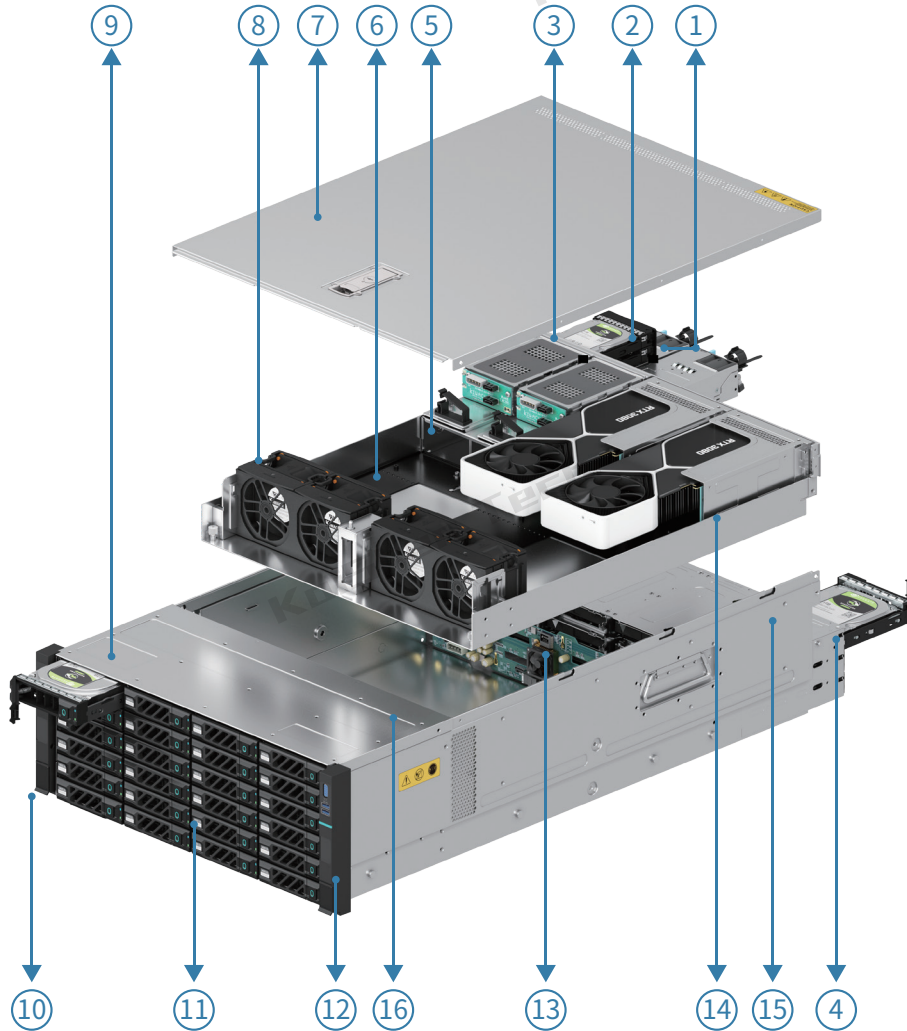

- | | |
|---|---|
| 1. Power Supply | 10. Left Bracket Assembly |
| 2. 2.5-inch Hard Drive Enclosure Module | 11. 3.5-inch Hard Drive Bracket
(Supports 2.5-inch Hard Drive) |
| 3. 2.5 Module | 12. Right Bracket Assembly |
| 4. 2U 12 Hard Drive Cage Assembly | 13. Hard Drive Backplane |
| 5. Power Supply Frame | 14. Motherboard Tray |
| 6. Gasket | 15. Chassis Base |
| 7. Rear Cover | 16. Front Cover |
| 8. Fan Module | |
| 9. Chassis Layout Diagram Sticker | |

1.3 Description of Front Panel and Hard Drive Bay

1.3.1 Front Panel and Indicator Lights:



Hard Drive Installation Diagram			
HD00	HD01	HD02	HD03
HD04	HD05	HD06	HD07
HD08	HD09	HD10	HD11
HD12	HD13	HD14	HD15
HD16	HD17	HD18	HD19
HD20	HD21	HD22	HD23

- | | | |
|-------------------------------------|---|---------------------------------|
| 1. Server Information Label | 2. Expand VGA Port | 3. USB 3.0 x 2 |
| 4. USB 2.0 x 2 | 5. Power Button + Power Indicator Light | 6. UID Button + Indicator Light |
| 7. Reset Button | 8. HDD Indicator Light | 9. Fault Indicator Light |
| 10. Ethernet Port 1 Indicator Light | 11. Ethernet Port 2 Indicator Light | |

Control Panel Buttons and Interface Description:

Power Button	Power button, press once to power on when the system is powered; In the powered-on state, press and hold for 5 seconds to shut down the system.
Reset Button	In the powered-on state, press once to restart the device.
UID Button	In the powered-on state, press once to illuminate the indicator light.

Control Panel Indicator Light Explanation:

Name	Color	Status	Description
Power Light	Blue	On	The server is in the powered-on state.
UID Light	Blue	On	The server is in the located state.
Fault Indicator Light	Red	On	The server is experiencing a malfunction.
Network 1 Indicator Light	Green	On	The network connection is normal.
Network 2 Indicator Light	Green	On	The network connection is normal.
HDD Indicator Light	Yellow	On	The hard drive is in operational status.

1.3.2 Hard Drive Installation and Hard Drive Tray Indicator Light Instructions:

3.5-inch Hard Drive Installation Guide:

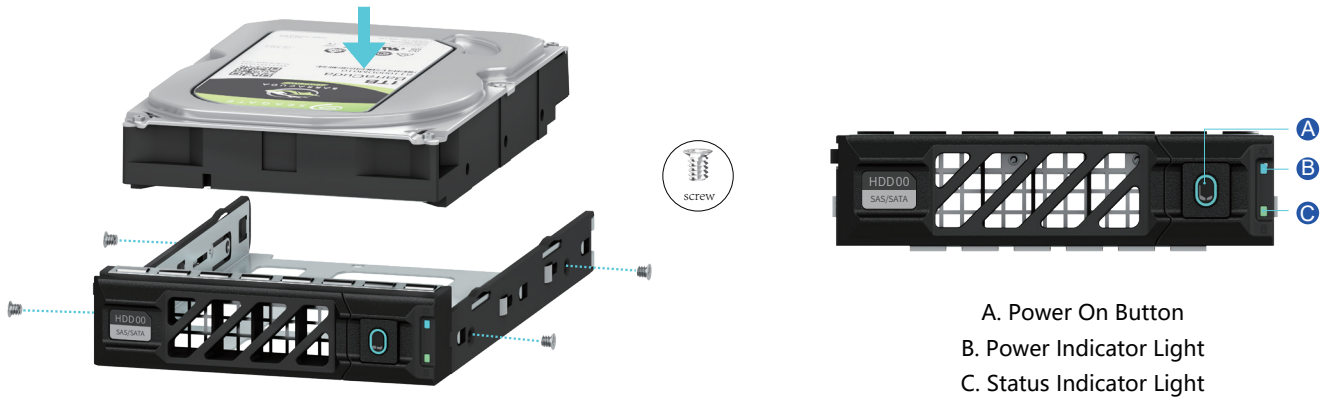

2.5-inch Hard Drive Installation Guide:

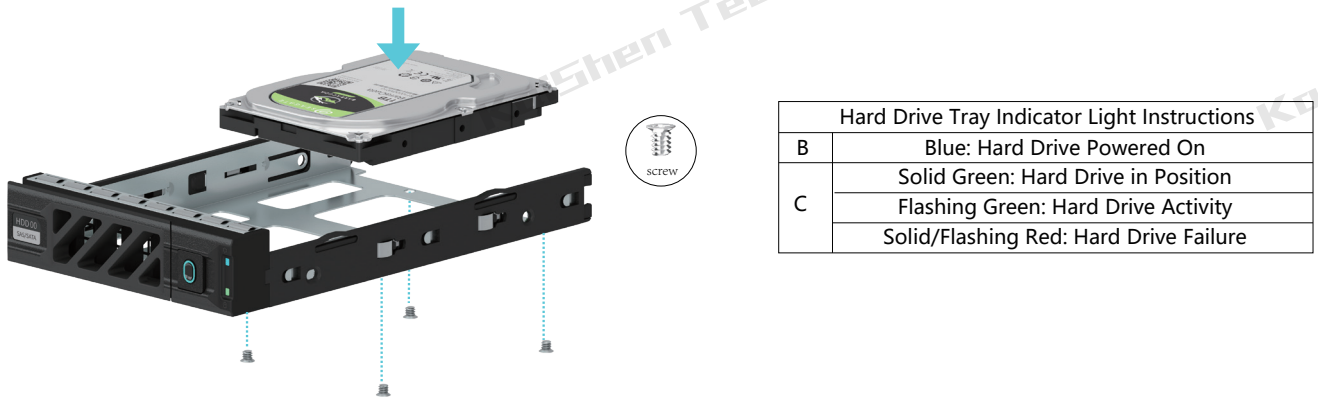

2.5-inch Hard Drive Installation Guide:

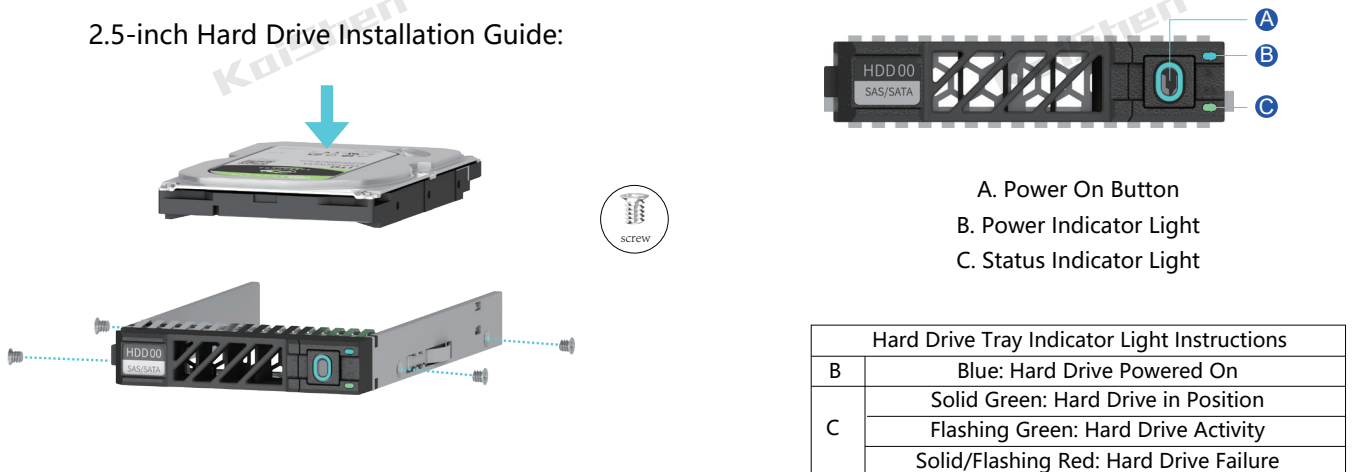

1.4 Hard Drive Backplane

1.4.1 24-disk backplane 12GB/SAS*8 + Nvme*4

TOP PLANE:

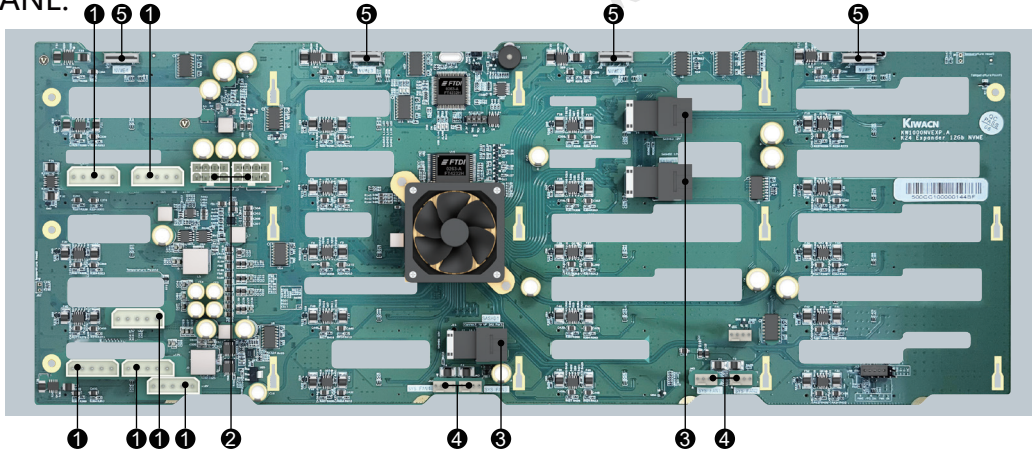

Label	Device Description	Function Description	Function Description
1	ATX 4P Power Connector	Backplane Power Transmission Connector, used for 12V power supply transmission. <i>(Pay attention to the orientation of the interface!!! And do not connect it simultaneously with the large 8-pin connector (③!!!)</i>	J2, J3, J4, J6, J59, J60
2	8P Power Connector	Backplane Power Transmission Connector, used for 12V power supply transmission <i>Note: Cannot be connected simultaneously with the large 8-pin connector (①)</i>	J5, J58
3	8SFF8643 Connector	Backplane Drive Slot Signal Interface	SASHD1, SASHD2, SASHD3
4	Fan Power Connector	For use with 4-pin fan connector	SYS FAN1, SYS FAN2, SYS FAN3, SYS FAN4
5	Nvme 8611 Connector	Nvme 3.0 Connector(Optional)	NVME1, NVME2, NVME3, NVME4

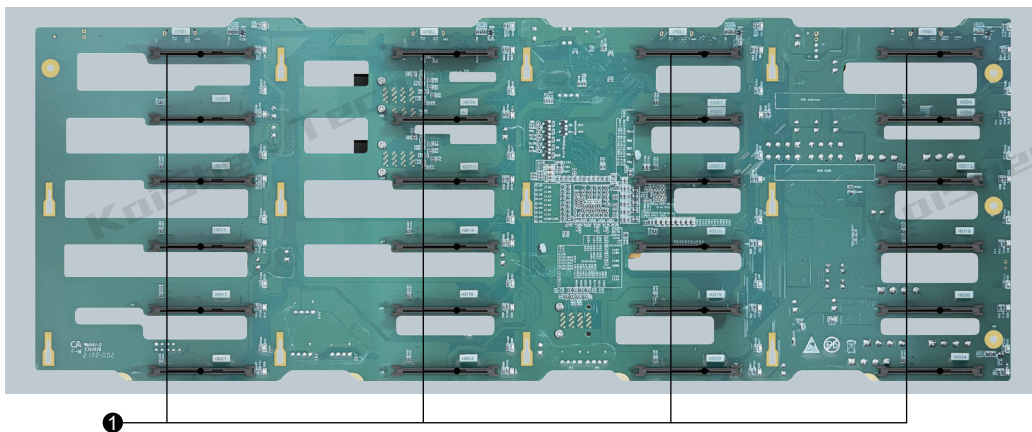

BOTTOM PLANE:

Label	Device Description	Function Description	Function Description
1	SAS/SATA Hard Drive Connector	1.Supports up to 12G/b SAS Hard Drives; 2.Supports up to 6G/b SATA Hard Drives; 3.Supports Hot-Swappable SAS/SATA Hard Drives.	HDD1, HDD2, HDD3, HDD4, HDD5, HDD6, HDD7, HDD8, HDD9, HDD10, HDD11, HDD12, HDD13, HDD14, HDD15, HDD16, HDD17, HDD18, HDD19, HDD20, HDD21, HDD22, HDD23, HDD24

1.4.1 12-Bay Backplane: 12GB/SAS*8 + Nvme*4

TOP Plane:

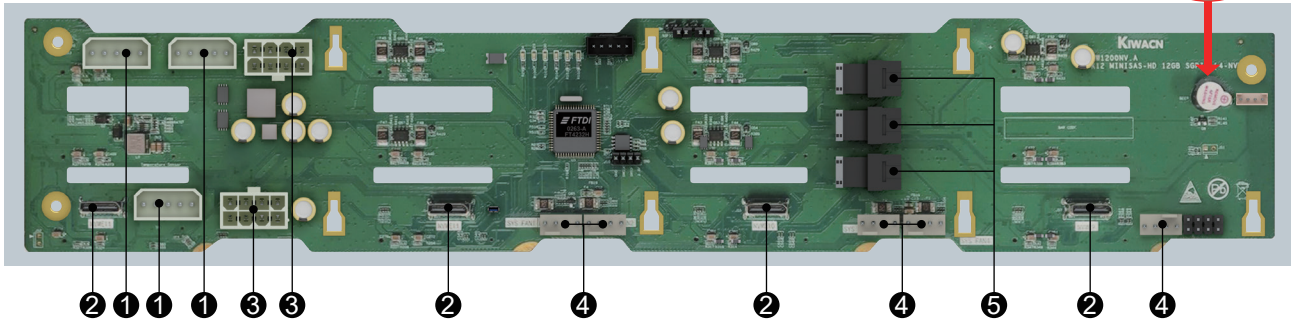

Label	Device Description	Function Description	Location Identifier
1	ATX 4P Power Connector	Backplane Power Transmission Connector, used for 12V power supply transmission. <i>(Pay attention to the orientation of the interface!!! And do not connect it simultaneously with the large 8-pin connector (③)!!!)</i>	J2, J4, J6
2	Nvme 8611 Connector	Nvme 3.0 Connector(Optional)	NVME9, NVME10, NVME11, NVME12
3	8P Power Connector	Backplane Power Transmission Connector, used for 12V power supply transmission <i>Note: Cannot be connected simultaneously with the large 8-pin connector (①)</i>	J5, J60
4	Fan Power Connector	For use with 4-pin fan connector	SYS FAN1, SYS FAN2, SYS FAN3, SYS FAN4
5	8SFF8643 Connector	Backplane Drive Slot Signal Interface	SASHD1, SASHD2, SASHD3

BOTTOM Plane:

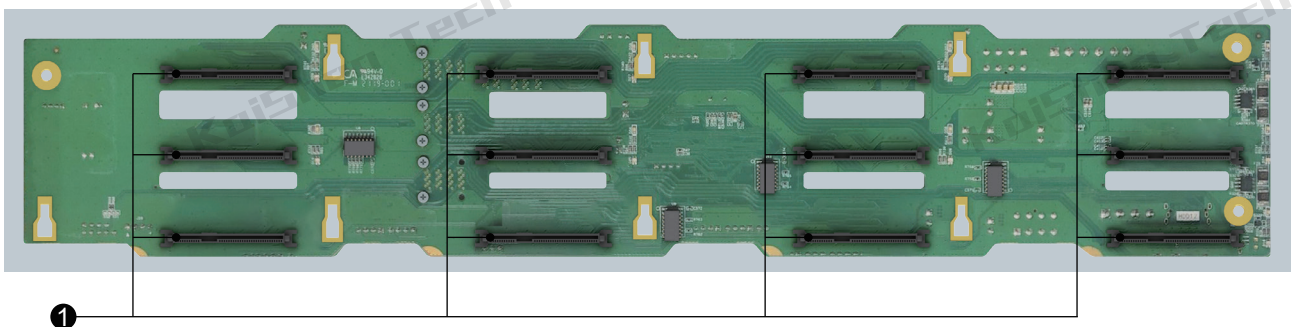

Label	Device Description	Function Description	Function Description
1	SAS/SATA Hard Drive Connector	1.Supports up to 12G/b SAS Hard Drives; 2.Supports up to 6G/b SATA Hard Drives; 3.Supports Hot-Swappable SAS/SATA Hard Drives.	HDD1, HDD2, HDD3, HDD4, HDD5, HDD6, HDD7, HDD8, HDD9, HDD10, HDD11, HDD12

1.5 Motherboard dimensions

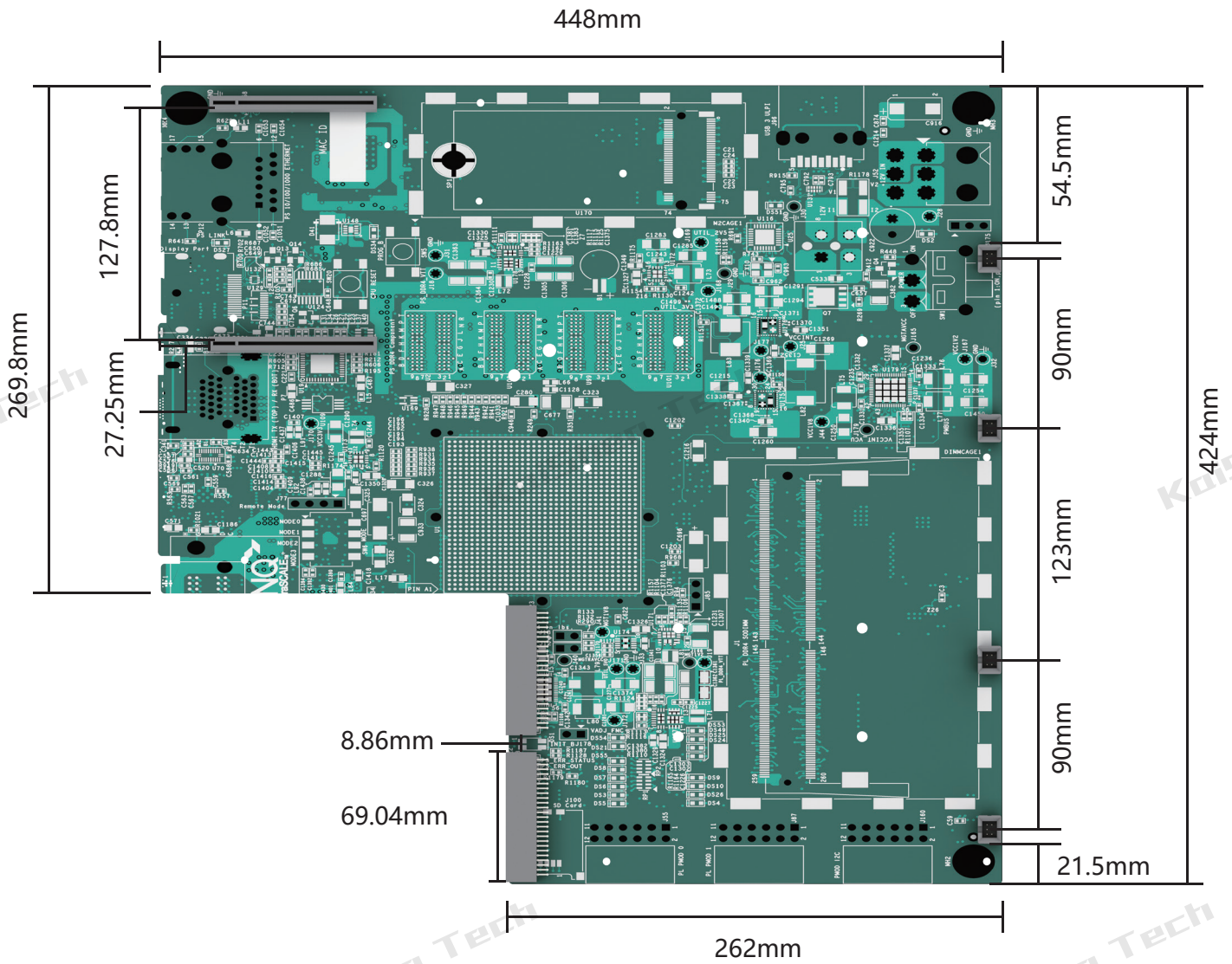

Chapter 2: Product Appearance

2.1 Chassis Structure

2.1.1 Chassis Diagram

4U24L:

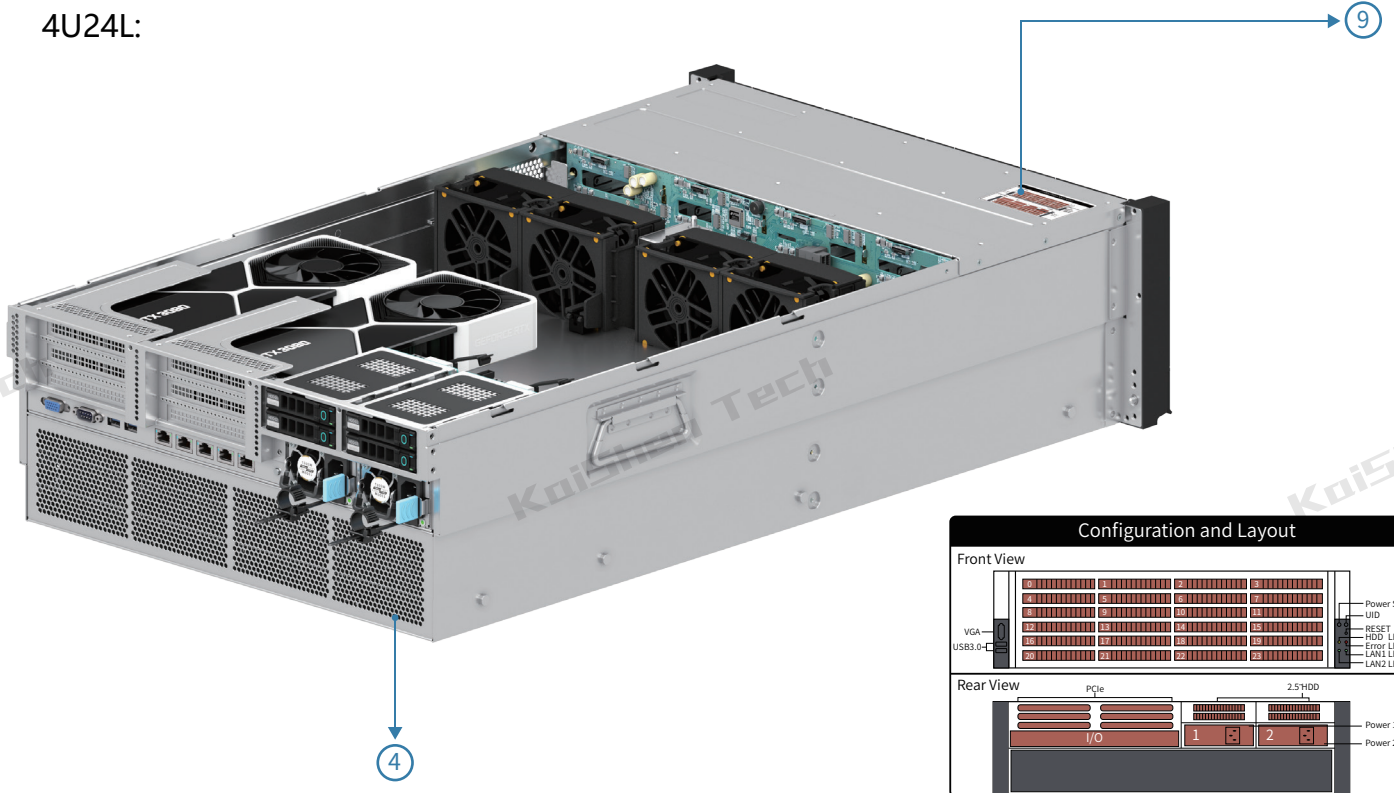

Notice: Caution, High Voltage Hazard

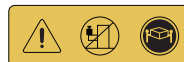

Notice: Caution, High Voltage Hazard

② Chassis Layout Diagram Sticker

④ Rear Panel

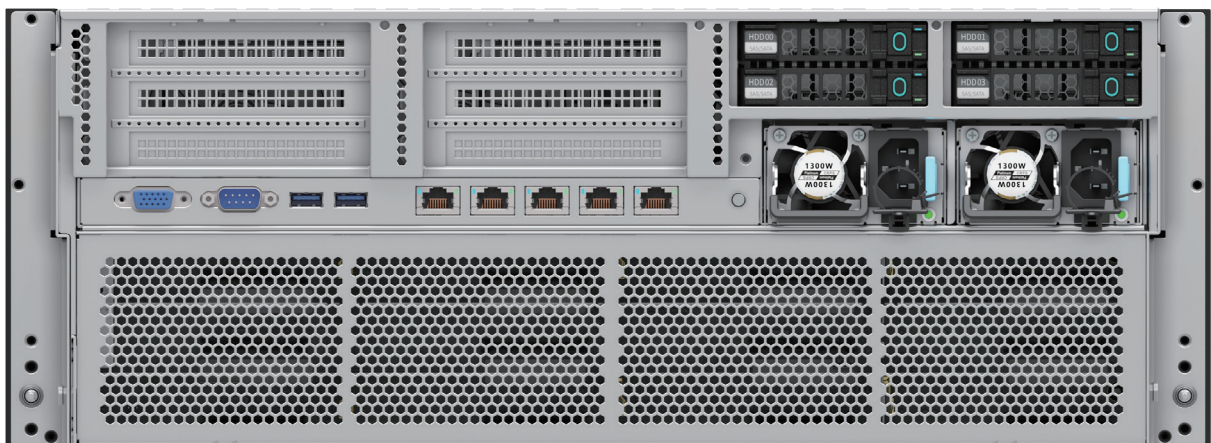

4U36L:

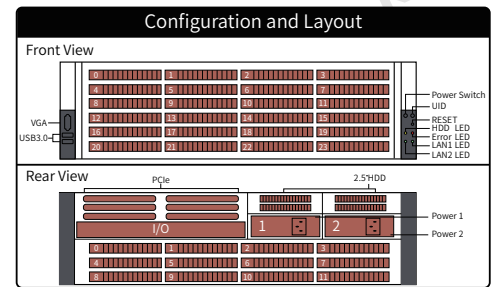
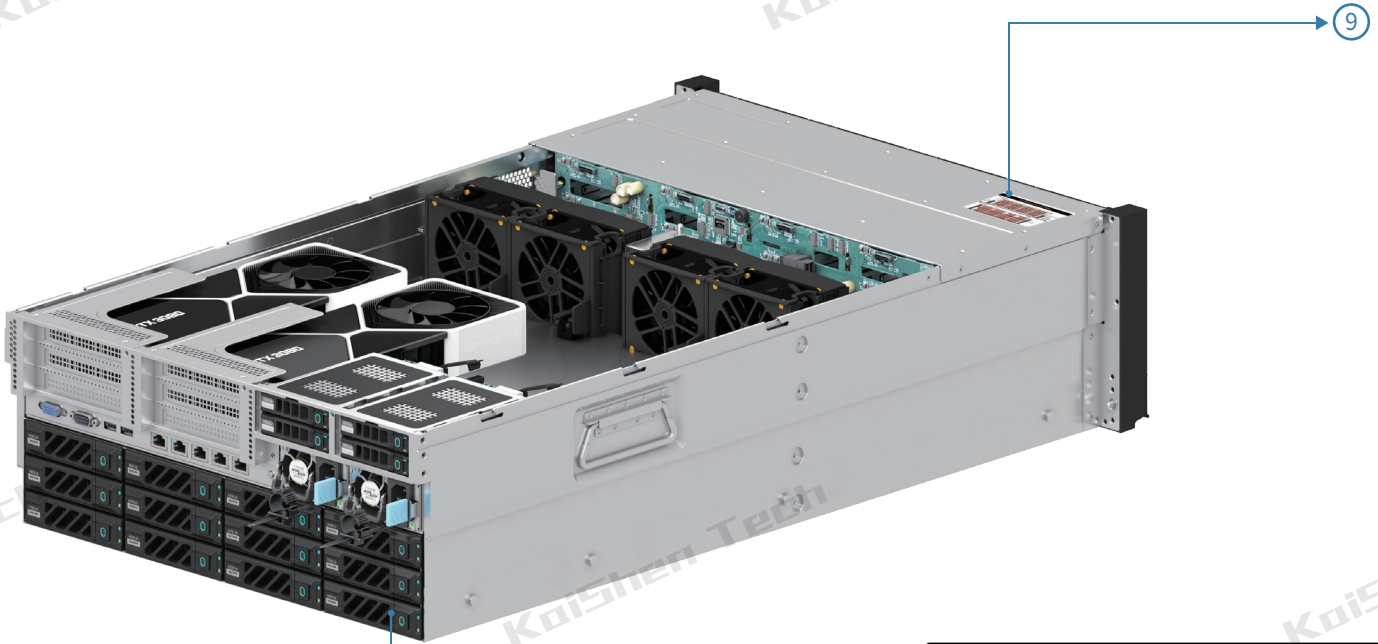

② Chassis Layout Diagram Sticker

⑬ 2U 12-Drive Cage Assembly



2.1.2 Server Chassis Images

4U24L:



Front View



45° Side View



45° Rear View

4U36L



Front View



45° Side View



45° Rear View

2.1.3 Server Dimensions

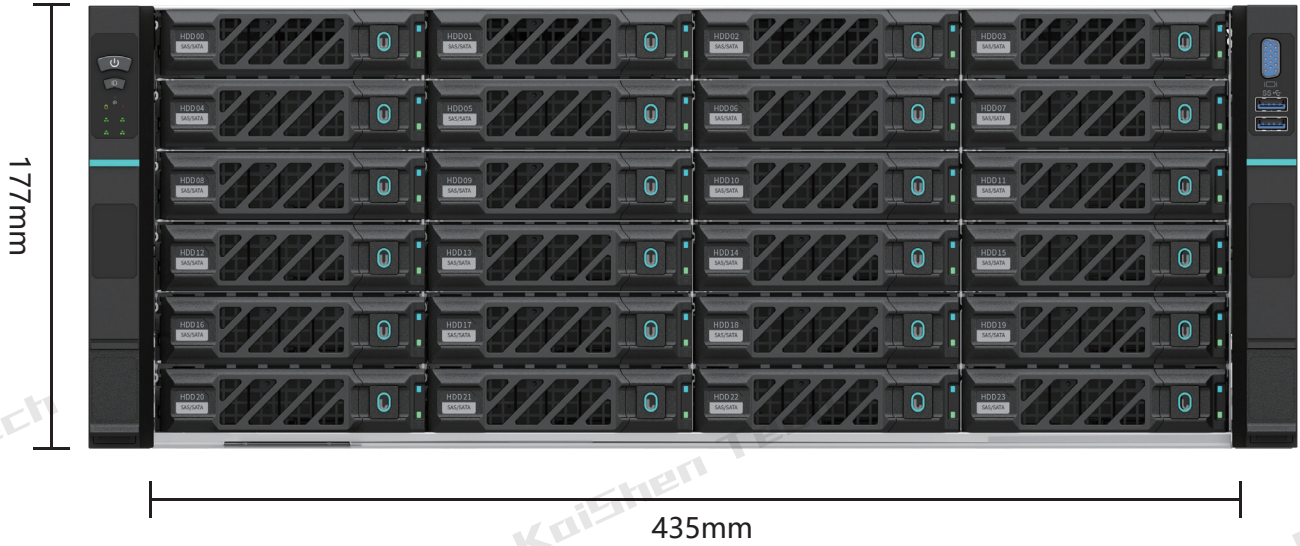

Front View (Dimensions)

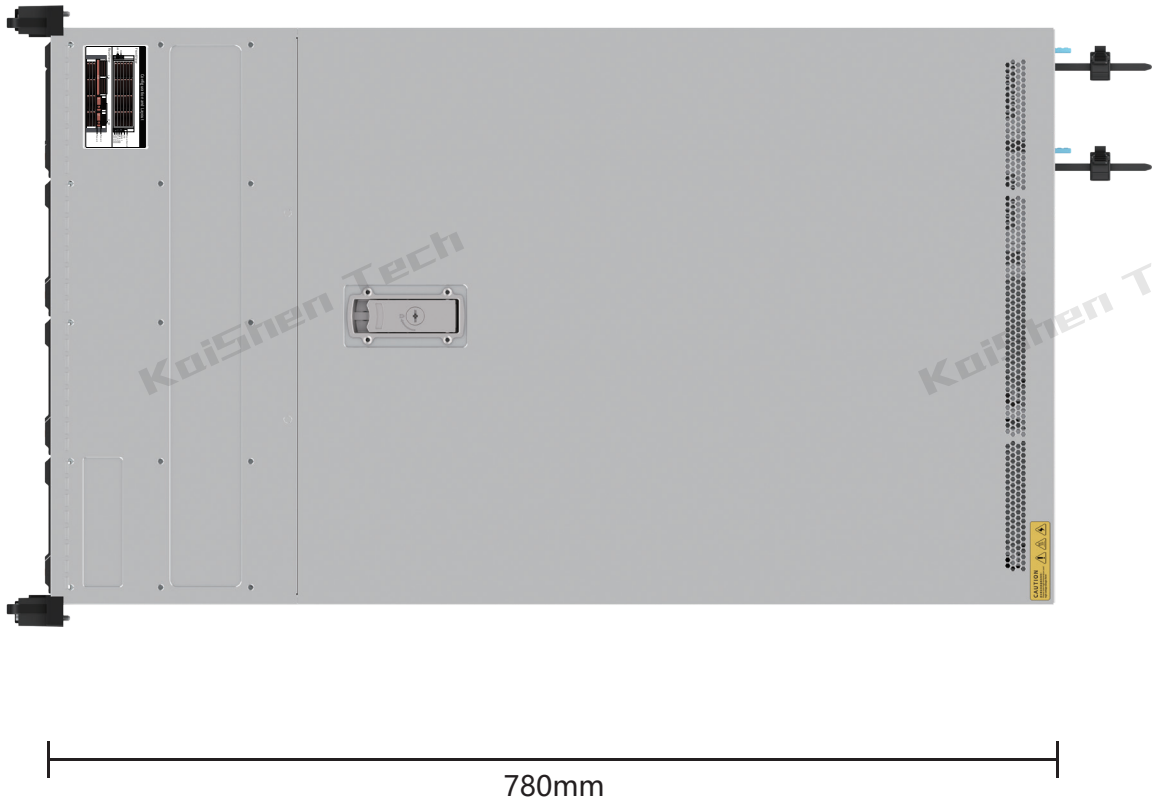

Top View (Dimensions)

Chapter 3 Product Loading and Unloading

3.1 Installation of Optical Drive

3.1.1 Steps of Installing the Optical Drive:

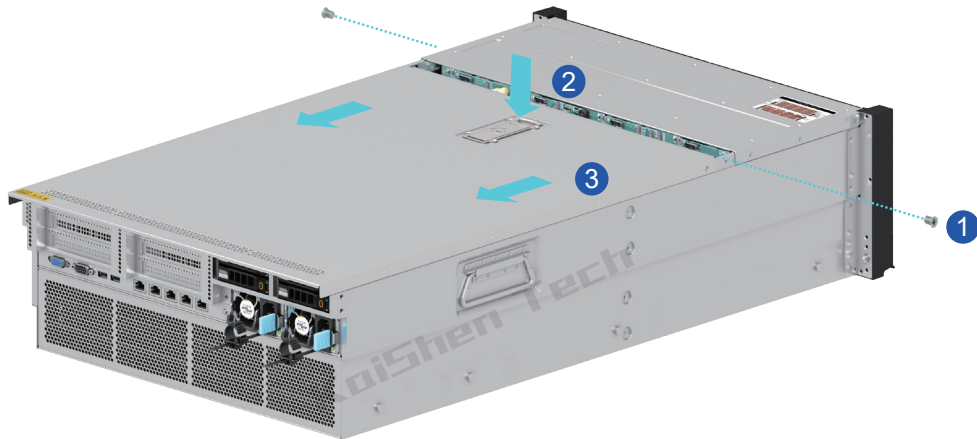

Loosen and remove the screws on both sides in the order shown in the diagram.

Follow the arrow direction to first unlatch and open the lock, then push backward and lift upward to remove the top cover.

3.1.2 Disassembly and assembly steps:

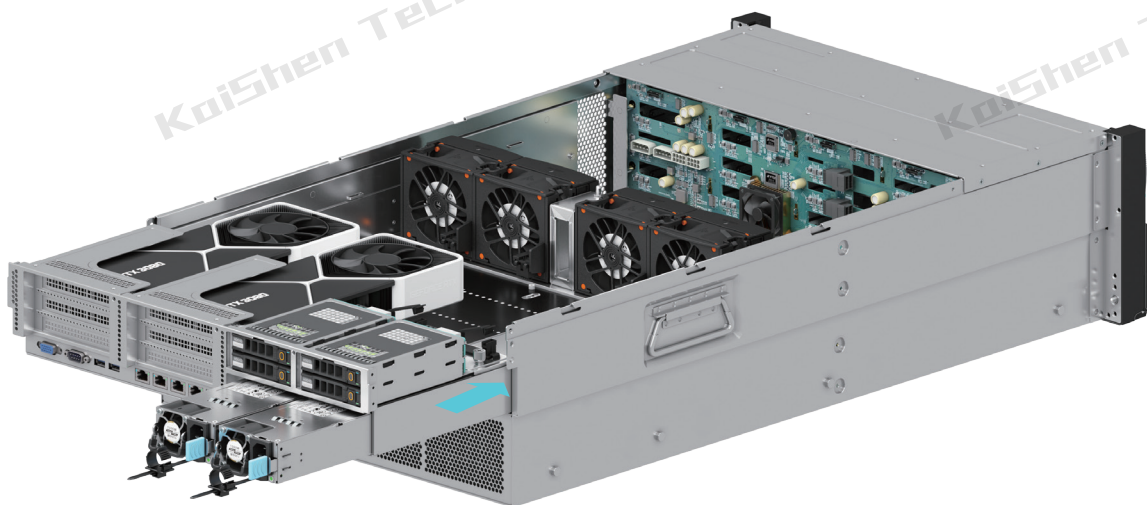

Chapter 4 Product Loading

4.1 Product Packaging

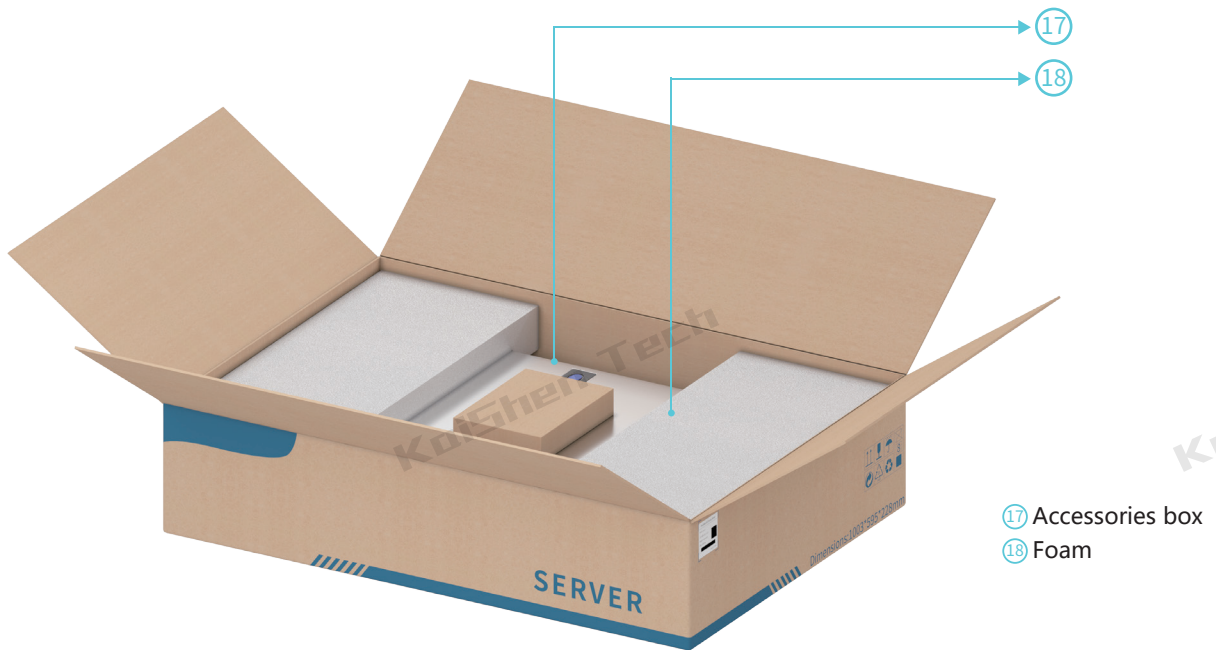

Place it inside the leather suitcase

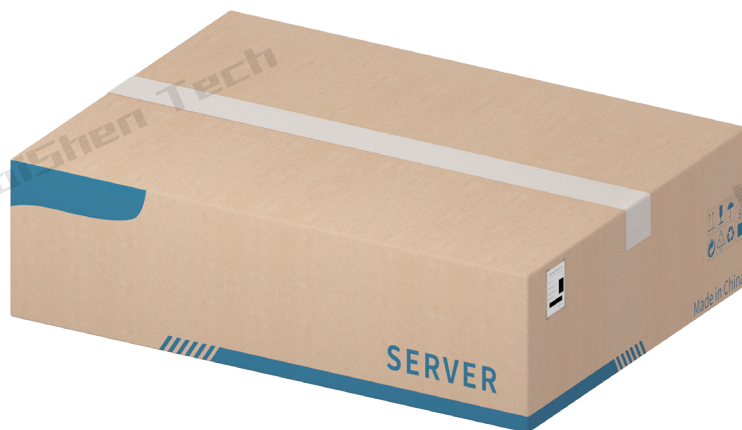

Seal the leather suitcase

Chapter 5 Product and Rail Installation

5.1 Install inner rails on both sides of the chassis

- 5.1.1 Securely attach the inner rail to the side wall of the chassis, and ensure that the inner rail's latch engages with the chassis T-pin.

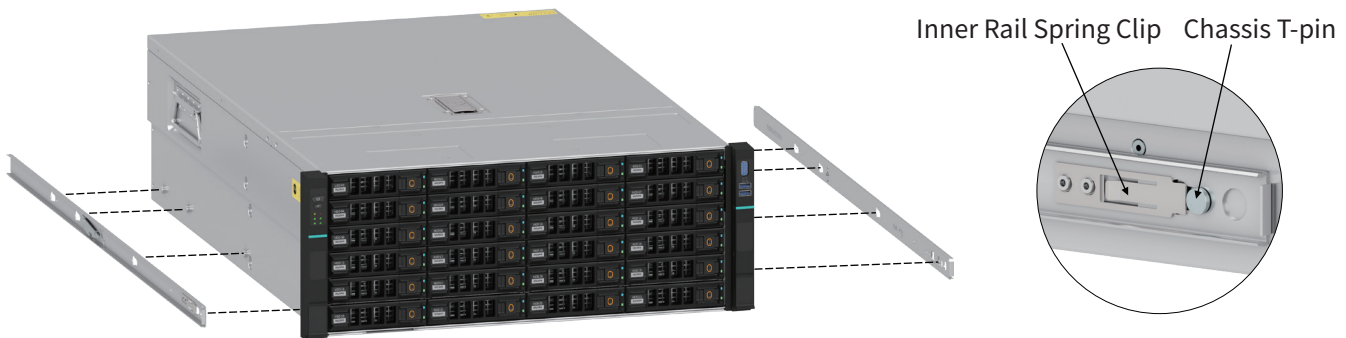

The inner rail spring clip engages with the chassis T-pin.

5.2 The chassis is mounted into the rack

(Note: Depending on the weight of the chassis, this step requires the cooperation of 2 to 4 people.)



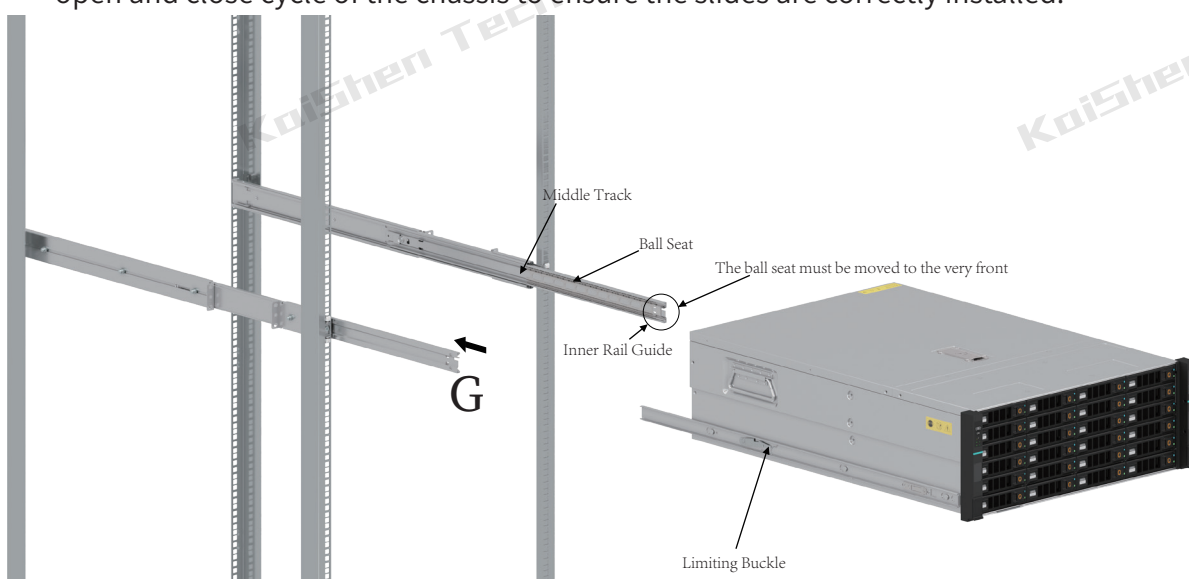

- 5.2.1 First, move the ball seat to the front end of the middle track. Then, along the G direction, horizontally insert the inner rail of the chassis into the ball seat.
- 5.2.2 When installing the rails, ensure that both sides of the server are kept level, and insert the inner rails simultaneously in a horizontal direction.
- 5.2.3 Ensure that the inner rails have entered the guides and ball seats before proceeding to push them into the chassis.
- 5.2.4 Only release the chassis after confirming that the inner rails have entered at least half of the ball seats.
- 5.2.5 There is a limiting buckle on the inner rail. When pushing it into the second section, you need to flip this buckle to enter the third section for complete closure.
- 5.2.5 If you find that the inner rails have not entered the ball seats, please repeat the above steps. If necessary, you can use your hand to assist the inner rails into the ball seats.
- 5.2.6 Unlock both levers on the sides, then push the chassis to fully close it. Perform at least one complete open and close cycle of the chassis to ensure the slides are correctly installed.







Note: Please make sure to insert horizontally in this direction. Otherwise, it may damage the ball seats and cause the slides to not function properly.

Chapter 6 Accessory Name and Part Number

6.1 Chassis Accessories List

No.	Part Number	Name	Image	Quantity
01	P/N:??????????????	Hard Drive Sticker		36
02	P/N:??????????????	Hard Drive Installation Screws		?
03	P/N:??????????????	Power Cable		
04	P/N:??????????????	SATA Cable		
05	P/N:??????????????	NVME Cable		

6.2 Optional Accessories List

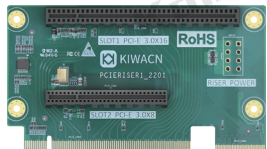
No.	Part Number	Name	Image
01	P/N:0304100006	Slide Rail	
02	P/N:0304090001	8654 Cable	
03	P/N:0201120006	2.5 SATA Moudle	
04	P/N:????????????????	2.5 NVME Moudle	
05	P/N:????????????????	8654 Fans Moudle	
06	P/N:????????????????	rasier Card	
07	P/N:????????????????	rasier Card	