

6U60 Series Server Chassis

Product Manual V1.0

CONTENTS

Chapter 1: Product Introduction.....	02
1.1 Product features.....	02
1.2 Chassis Structure.....	03
1.3 Description of Front Panel and Hard Drive Bay.....	05
1.3.1 Front Panel and Indicator Lights.....	05
1.3.2 Hard Drive Installation and Hard Drive Tray Indicator Light Instructions.....	06
1.4 Hard Drive Backplane.....	07
1.4.1 24-Disk Backplane: 12GB/SAS*8 + Nvme*4.....	07
1.4.2 12-Disk Backplane: 12GB/SAS*8 + Nvme*4.....	08
1.5 Motherboard size.....	09
Chapter 2: Product Appearance.....	10
2.1 Chassis Structure.....	10
2.1.1 Chassis Diagram.....	10
2.1.2 Server Chassis Images.....	12
2.1.3 Server Dimensions.....	14
Chapter 3: Product Loading and Unloading.....	15
3.1 Removal of the Rear Top Cover.....	15
3.1.1 Disassembly Steps.....	15
3.1.2 Installation Steps.....	15
Chapter 4: Product Loading.....	16
4.1 Product Packaging.....	16
Chapter 5: Product and Rail Installation.....	17
5.1 Install inner rails on both sides of the chassis.....	17
5.2 The chassis is mounted into the rack.....	17
Chapter 6: Accessory Name and Part Number.....	18
6.1 Chassis Accessories List.....	18
6.2 Optional Accessories List.....	19

Chapter 1: Product Introduction

1.1 Product Features

Product Code	K36003
Chassis Category	6U Rack mount
Material	SGCC1.2mm(Taiwan)
MB Form Factor	4-way special-shaped motherboard
Dimensions (D*W*H)	850 x 449 x 263 (mm) 33.46" x 17.68" x 10.35"
Drive Bays	3.5" Hot-swap: 60 Outernal 2.5": 2
PSU Form Factor	Power Supply Model Redundant x 2
Indicators	1 * Power Status , 2 * LAN Activity, 1 * UID Status , 1 * HDD Status, 1 Warning Status
Front Control	Power On/Off, System Reset, 2 x USB 3.0
Cooling Fans	Middle: 4 x 8038(15000PWM) + 8 x 8038(7500PWM)
Expansion Slots	24pcie To 16pcie and 8pice(Option) , 24pcie To 3*8x(Option), 654 To 8x(Option) , 8pcie(Option)
HDD Backplane	24-port 12Gb/s Expander - SAS x 2, 12-port 12Gb/s Expander - SAS x 1
Rack rails	P/N:0304100007(Option)
Net Weight	38kg
Gross Weight	50kg
Package size(D*W*H)	1130x680x468mm

1.2 Chassis Structure

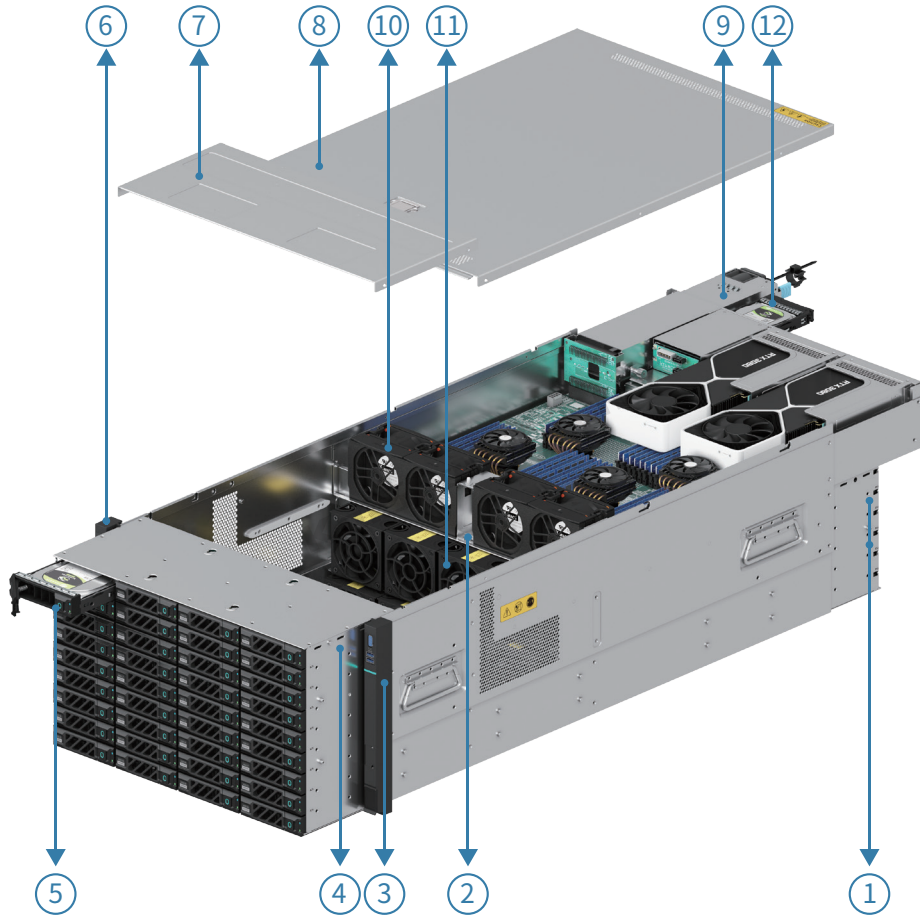

1. 4u36 hard drive cage assembly
2. motherboard tray
3. Right Bracket Assembly
4. 6u36 hard drive cage assembly
5. 3.5-inch Hard Drive Bracket
(Supports 2.5-inch Hard Drive)
6. Left Bracket Assembly

7. Front Cover
8. Rear Panel
9. power supply
10. 8038cooling fans(15000PWM)
11. 8038cooling fans(7500PWM)
12. 2.5-inch Hard Drive Enclosure Module

1.3 Description of Front Panel and Hard Drive Bay

1.3.1 Front Panel and Indicator Lights:



HD00	HD01	HD02	HD03
HD04	HD05	HD06	HD07
HD08	HD09	HD10	HD11
HD12	HD13	HD14	HD15
HD16	HD17	HD18	HD19
HD20	HD21	HD22	HD23

- | | | |
|-------------------------------------|---|---------------------------------|
| 1. Server Information Label | 2. Expand VGA Port | 3. USB 3.0 x 2 |
| 4. USB 2.0 x 2 | 5. Power Button + Power Indicator Light | 6. UID Button + Indicator Light |
| 7. Reset Button | 8. HDD Indicator Light | 9. Fault Indicator Light |
| 10. Ethernet Port 1 Indicator Light | 11. Ethernet Port 2 Indicator Light | |

Control Panel Buttons and Interface Description:

Power Button	Power button, press once to power on when the system is powered; In the powered-on state, press and hold for 5 seconds to shut down the system.
Reset Button	In the powered-on state, press once to restart the device.
UID Button	In the powered-on state, press once to illuminate the indicator light.

Control Panel Indicator Light Explanation:

Name	Color	Status	Description
Power Light	Blue	On	The server is in the powered-on state.
UID Light	Blue	On	The server is in the located state.
Fault Indicator Light	Red	On	The server is experiencing a malfunction.
Network 1 Indicator Light	Green	On	The network connection is normal.
Network 2 Indicator Light	Green	On	The network connection is normal.
HDD Indicator Light	Yellow	On	The hard drive is in operational status.

1.3.2 Hard Drive Installation and Hard Drive Tray Indicator Light Instructions:

3.5-inch Hard Drive Installation Guide:

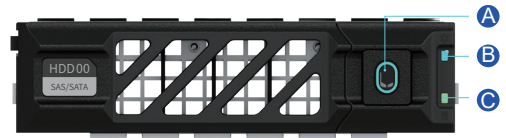

- A. Power On Button
- B. Power Indicator Light
- C. Status Indicator Light

2.5-inch Hard Drive Installation Guide:

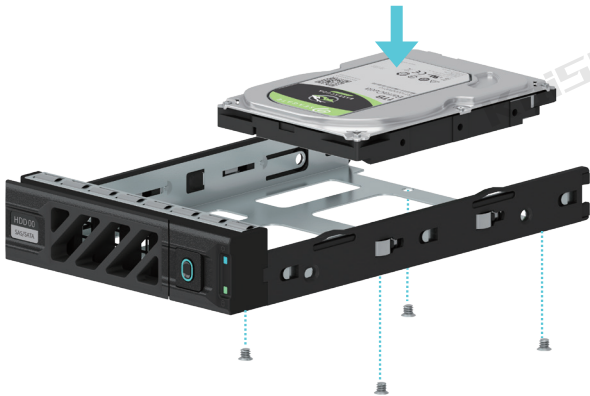

Hard Drive Tray Indicator Light Instructions	
B	Blue: Hard Drive Powered On Solid Green: Hard Drive in Position
C	Flashing Green: Hard Drive Activity Solid/Flashing Red: Hard Drive Failure

2.5-inch Hard Drive Installation Guide:

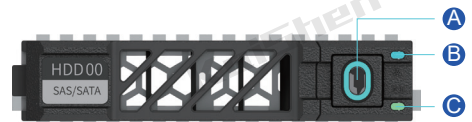

- A. Power On Button
- B. Power Indicator Light
- C. Status Indicator Light

Hard Drive Tray Indicator Light Instructions	
B	Blue: Hard Drive Powered On Solid Green: Hard Drive in Position
C	Flashing Green: Hard Drive Activity Solid/Flashing Red: Hard Drive Failure

1.4 Hard Drive Backplane

1.4.1 24-disk backplane 12GB/SAS*8 + Nvme*4

TOP PLANE:

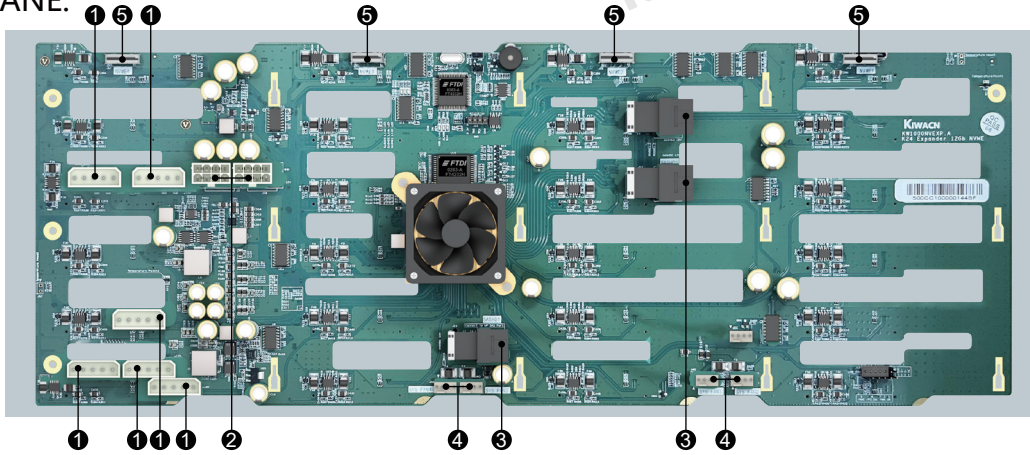

Label	Device Description	Function Description	Function Description
1	ATX 4P Power Connector	Backplane Power Transmission Connector, used for 12V power supply transmission. <i>(Pay attention to the orientation of the interface!!! And do not connect it simultaneously with the large 8-pin connector (③)!!!)</i>	J2, J3, J4, J6, J59, J60
2	8P Power Connector	Backplane Power Transmission Connector, used for 12V power supply transmission <i>Note: Cannot be connected simultaneously with the large 8-pin connector (①)</i>	J5, J58
3	8SFF8643 Connector	Backplane Drive Slot Signal Interface	SASHD1, SASHD2, SASHD3
4	Fan Power Connector	For use with 4-pin fan connector	SYS FAN1, SYS FAN2, SYS FAN3, SYS FAN4
5	Nvme 8611 Connector	Nvme 3.0 Connector(Optional)	NVME1, NVME2, NVME3, NVME4

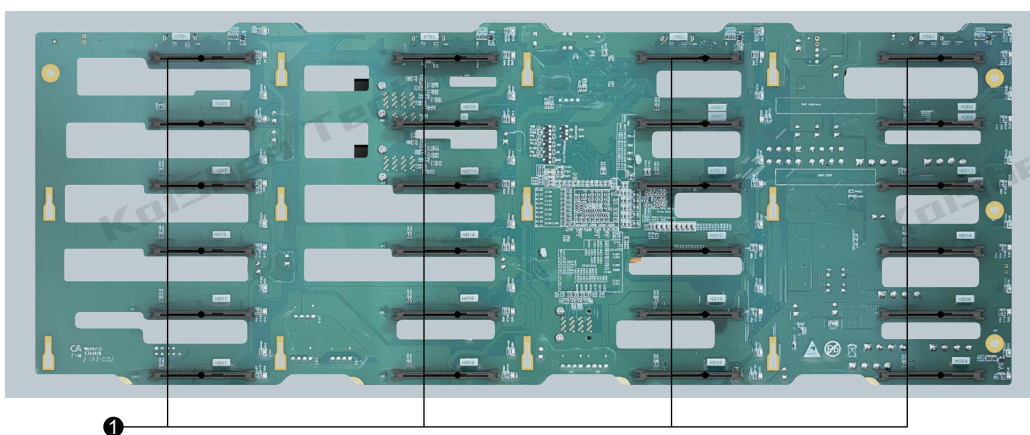

BOTTOM PLANE:

Label	Device Description	Function Description	Function Description
1	SAS/SATA Hard Drive Connector	1.Supports up to 12G/b SAS Hard Drives; 2.Supports up to 6G/b SATA Hard Drives; 3.Supports Hot-Swappable SAS/SATA Hard Drives.	HDD1, HDD2, HDD3, HDD4, HDD5, HDD6, HDD7, HDD8, HDD9, HDD10, HDD11, HDD12, HDD13, HDD14, HDD15, HDD16, HDD17, HDD18, HDD19, HDD20, HDD21, HDD22, HDD23, HDD24

1.4.1 12-Bay Backplane: 12GB/SAS*8 + Nvme*4

TOP Plane:

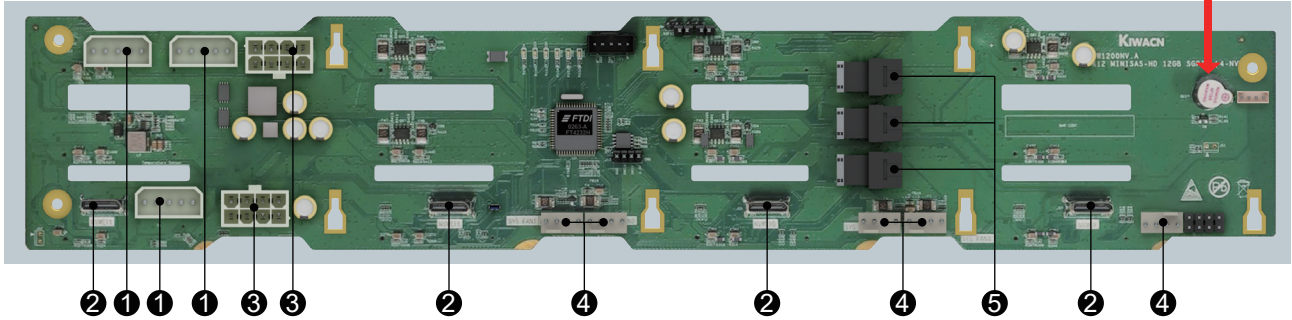

Label	Device Description	Function Description	Location Identifier
1	ATX 4P Power Connector	Backplane Power Transmission Connector, used for 12V power supply transmission. <i>(Pay attention to the orientation of the interface!!! And do not connect it simultaneously with the large 8-pin connector (③)!!!)</i>	J2, J4, J6
2	Nvme 8611Connector	Nvme 3.0 Connector(Optional)	NVME9, NVME10, NVME11, NVME12
3	8P Power Connector	Backplane Power Transmission Connector, used for 12V power supply transmission <i>Note: Cannot be connected simultaneously with the large 8-pin connector (①)</i>	J5, J60
4	Fan Power Connector	For use with 4-pin fan connector	SYS FAN1, SYS FAN2, SYS FAN3, SYS FAN4
5	8SFF8643 Connector	Backplane Drive Slot Signal Interface	SASHD1, SASHD2, SASHD3

BOTTOM Plane:

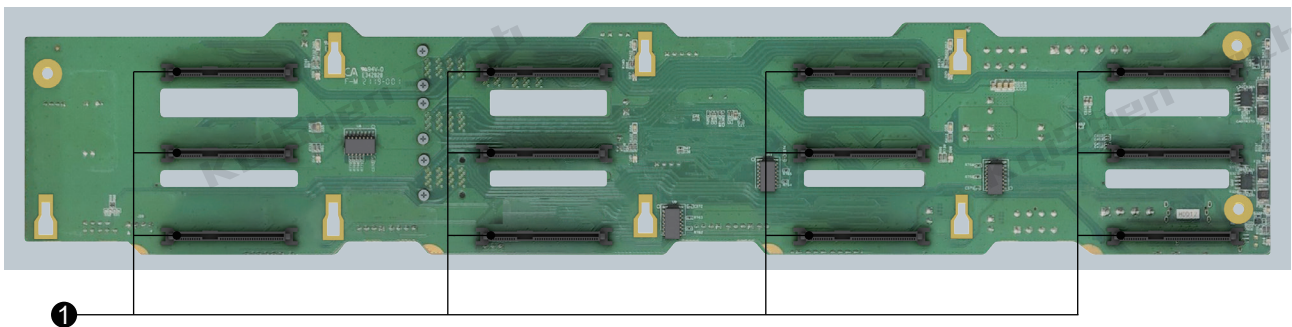

Label	Device Description	Function Description	Function Description
1	SAS/SATA Hard Drive Connector	1.Supports up to 12G/b SAS Hard Drives; 2.Supports up to 6G/b SATA Hard Drives; 3.Supports Hot-Swappable SAS/SATA Hard Drives.	HDD1, HDD2, HDD3, HDD4, HDD5, HDD6, HDD7, HDD8, HDD9, HDD10, HDD11, HDD12

1.5 Motherboard dimensions

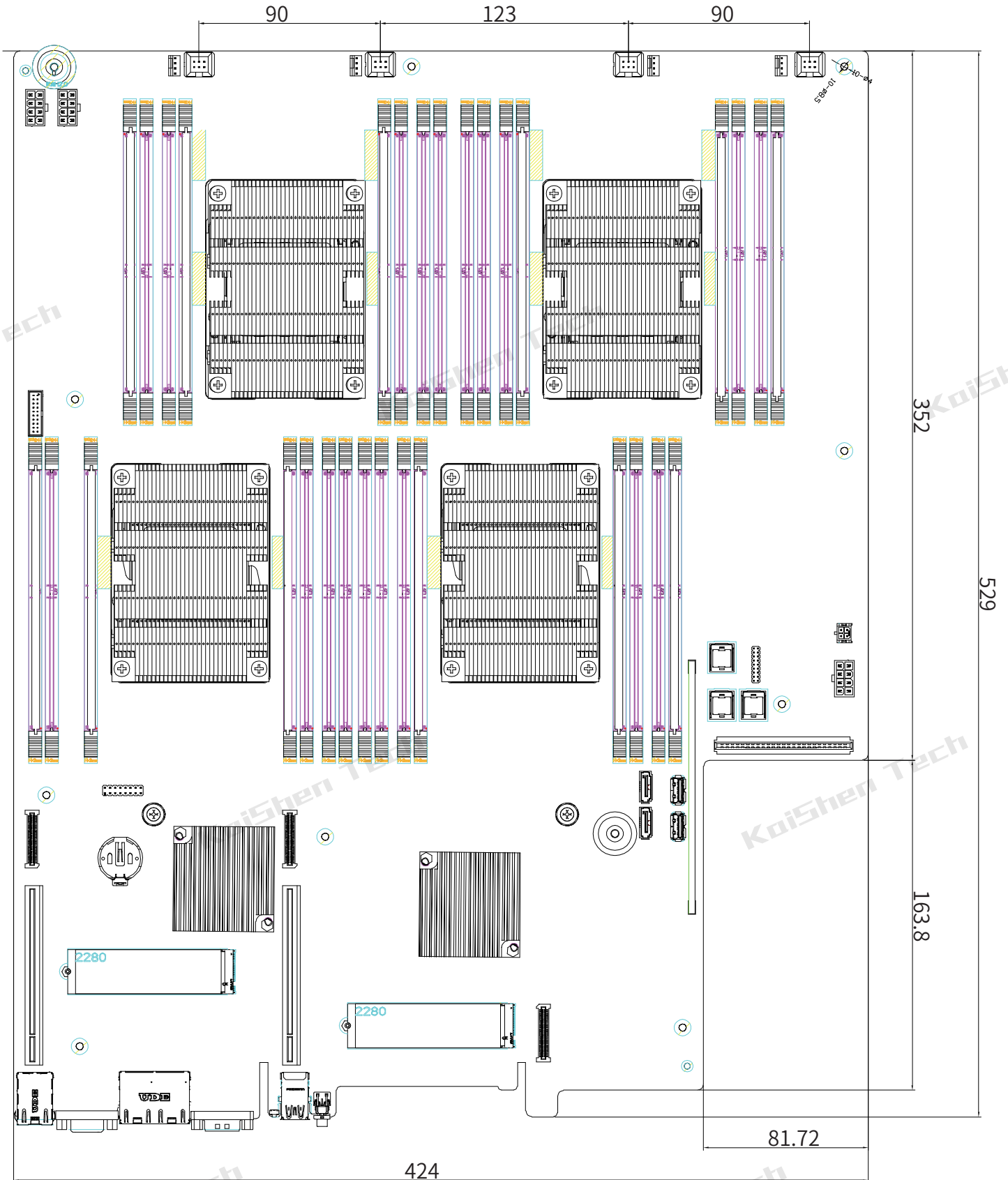

Chapter 2: Product Appearance

2.1 Chassis Structure

2.1.1 Chassis Diagram

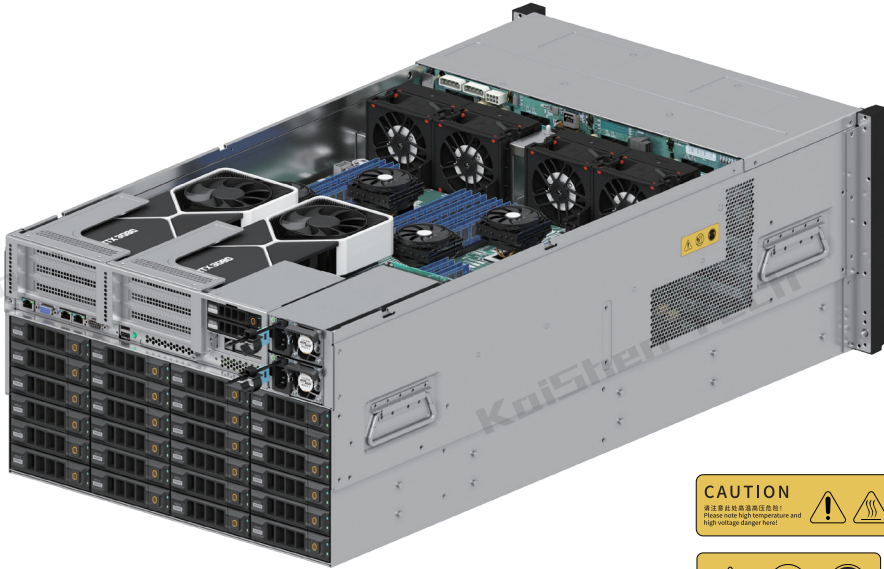

Notice: Caution, High Voltage Hazard



Notice: Do not place liquids, handle with care



2.1.2 Server Chassis Images



Front View



45° Side View



45° Rear View

2.1.3 Server Dimensions

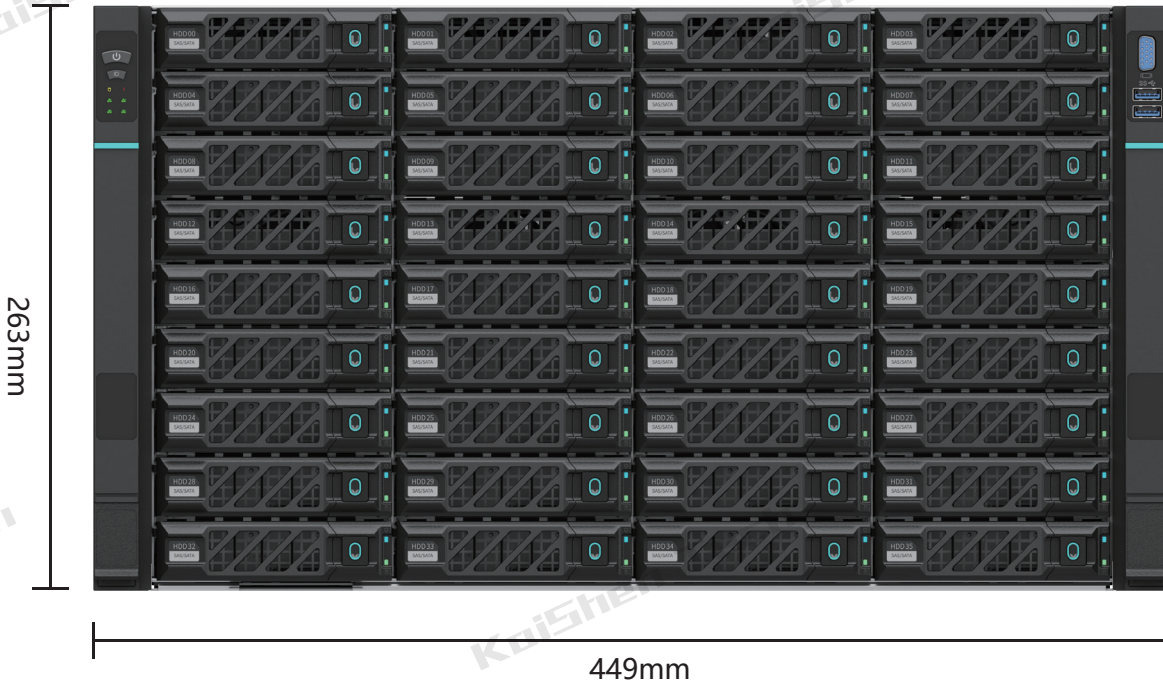

Front View (Dimensions)

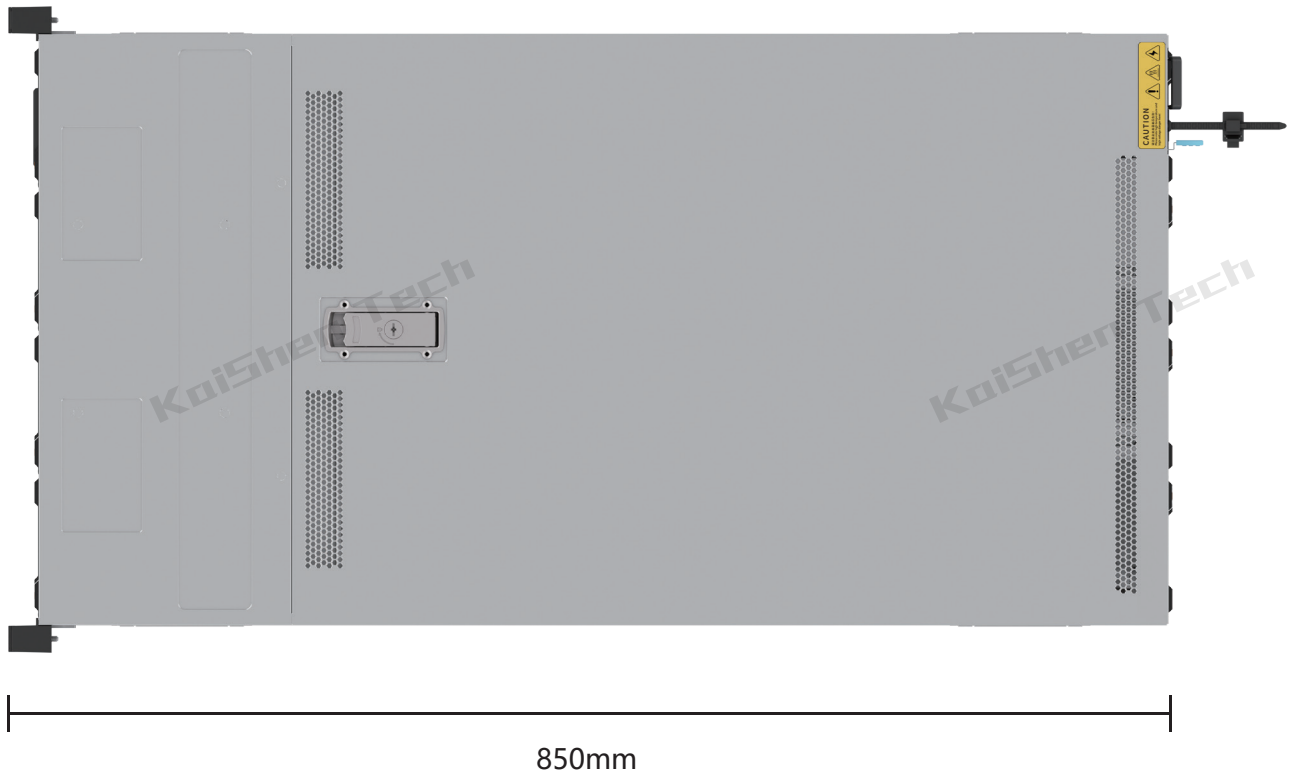

Top View (Dimensions)

Chapter 3 Product Loading and Unloading

3.1 Installation of Optical Drive

3.1.1 Steps of Installing the Optical Drive:

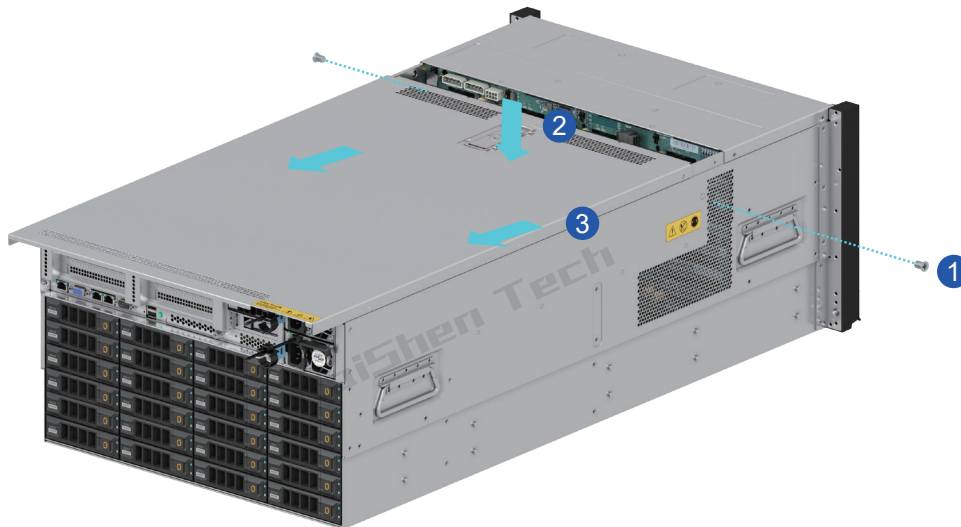

Loosen and remove the screws on both sides in the order shown in the diagram.

Follow the arrow direction to first unlatch and open the lock, then push backward and lift upward to remove the top cover.

3.1.2 Disassembly and assembly steps:

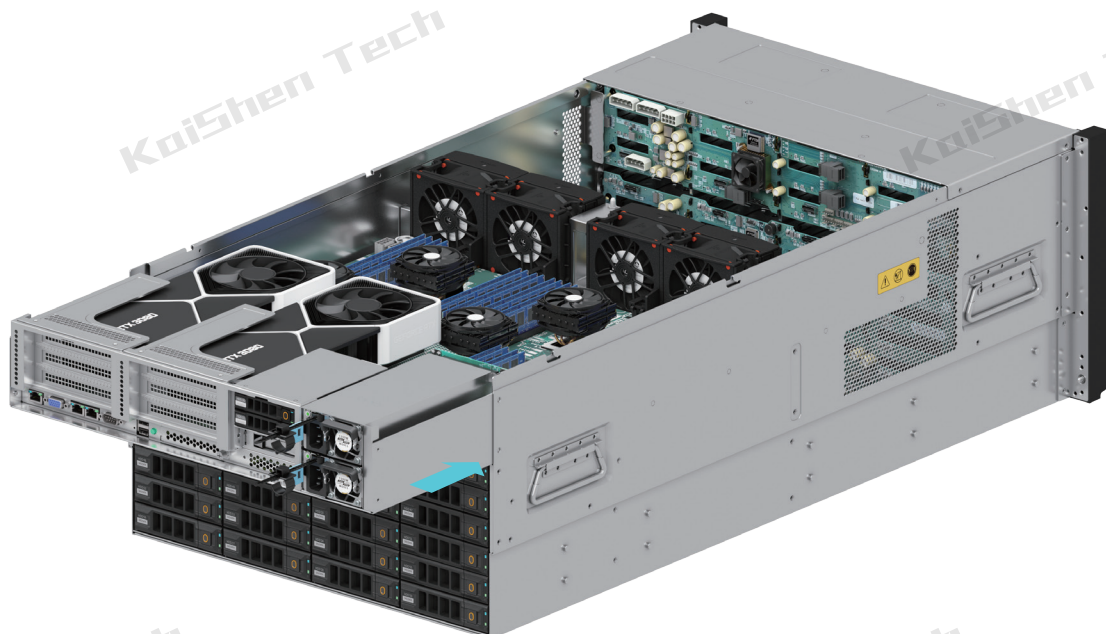

Chapter 4 Product Loading

4.1 Product Packaging

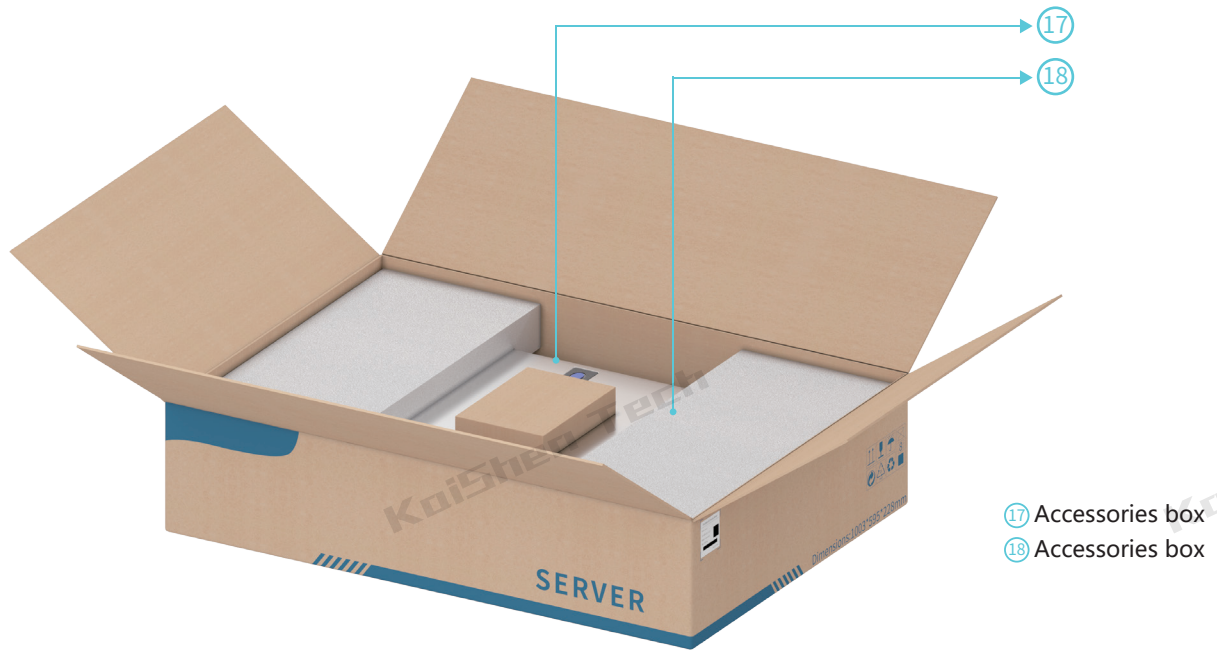

Place it inside the leather suitcase

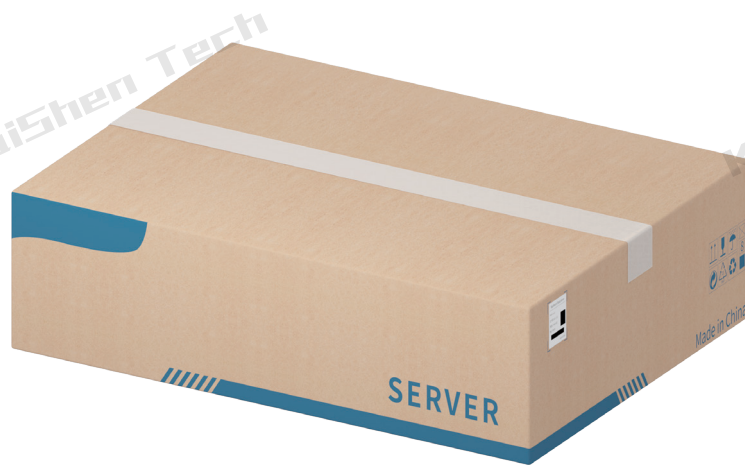

Seal the leather suitcase

Chapter 5 Product and Rail Installation

5.1 Install inner rails on both sides of the chassis

5.1.1 Install and secure the inner rails to the side walls of the chassis.



5.2 The chassis is mounted into the rack

(Note: Depending on the weight of the chassis, this step requires the cooperation of 2 to 4 people.)

- 5.2.1 First, move the ball seat to the front end of the middle rail, and then insert the inner rail on the chassis horizontally along the G direction.
- 5.2.2 When installing the guide rails, the server must remain horizontal and the inner rails on both sides must be inserted horizontally at the same time.
- 5.2.3 Make sure the inner rail enters the guide piece before pushing the chassis in.
- 5.2.4 Make sure the inner rail is at least halfway in before you release the chassis.
- 5.2.5 There is a limit snap-in on the inner rail. When pushing in the second section, you need to push this snap-in to enter the third section until it is fully closed.
- 5.2.5 If you find that the inner rail does not enter the guide, please repeat the above steps. If necessary, you can press the auxiliary inner rail with your hand to enter.
- 5.2.6 Unlock the levers on both sides and push the chassis to the fully closed state. Pull the chassis through at least one fully opened and closed process to ensure that the slide rails are installed correctly.

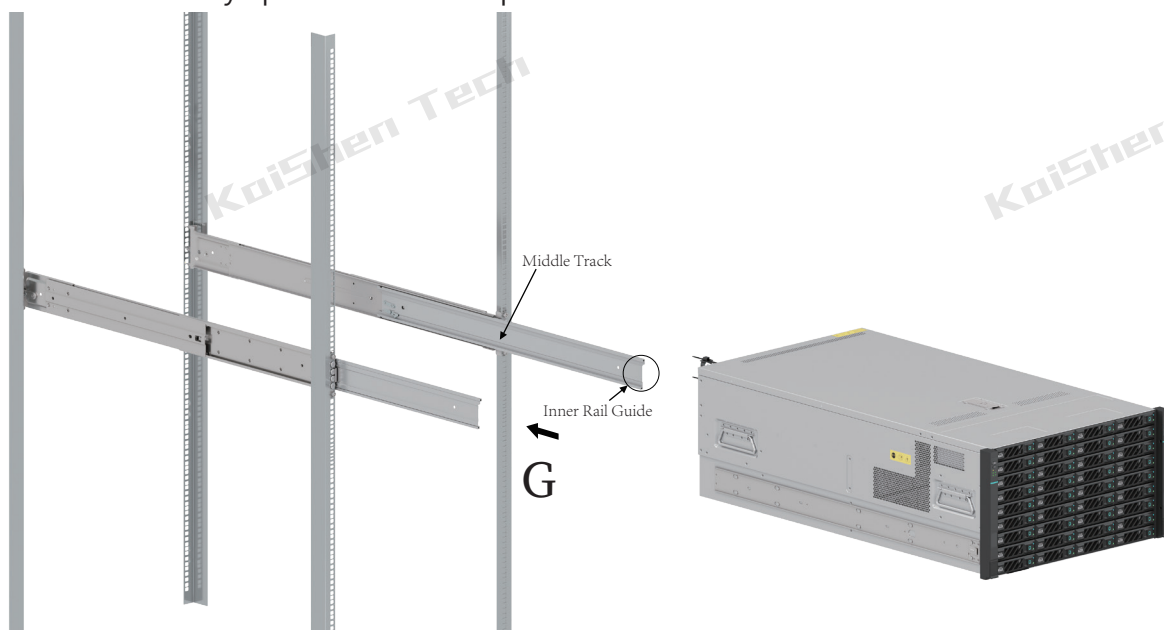





Note: Please be sure to insert it horizontally in this direction, otherwise it will be easily damaged and the slide rail will not slide normally.

Chapter 6 Accessory Name and Part Number

6.1 Chassis Accessories List

No.	Part No.	Name	Photograph	Quantity
01	P/N: 0305010001	2.5-inch hard drive screws (Compatible with 3.5-inch hard drive bay)		56
02	P/N:0305010031	3.5inch hard drive screws		48
03	P/N:0305010124	2.5-inch Hard drive retaining screws		4
04	P/N:0305070003	Motherboard heightening column (Motherboard thickness1.6mm)		12
05	P/N:0305010203	Motherboard screws		12
06	P/N:0202110015	2.5Hard drive holder (2U8)		2
07	P/N:0305010125	Fixed single power/ATX		3
08	P/N:0305010025	Fixed redundancy		8
09	P/N:04.02.0009	hard drive sticker (00-11)		1

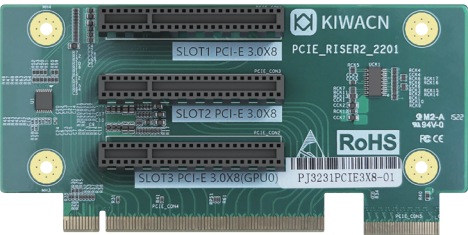
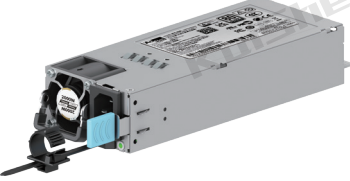
6.2 Optional Accessories List

No.	Part Number	Name	Image
01	P/N:0304100007	Rail silde	
02	P/N:0304090001	wire	
03	P/N:0302050004	2u/riser 卡 (PCIE24X TO PCIE16X + PCIE8X)	
04	P/N:0302050005	2u/riser 卡 (PCIE24X TO 3*PCIE8X)	
05	P/N:0304010020	the Great Wall CPRS2000w	
06	P/N:0201120006	2.5 NVME Moudle	

No.	Part Number	Name	Image
07	P/N:0304090002	2.5 SATA Moudle	